

# Haier

**User Manual**

**HWF70BW1**



## Thanks for purchasing a Haier Product

Please read these instructions carefully before using this appliance. The instructions contain important information which will help you get the best out of the appliance and ensure safe and proper installation, use and maintenance.

Keep this manual in a convenient place so you can always refer to it for the safe and proper use of the appliance.

If you sell the appliance, give it away, or leave it behind when you move house, make sure you also pass on this manual so that the new owner can become familiar with the appliance and safety warnings.

## Accessories

Check the accessories and literature in accordance with this list:

1x User manual



1x Drain hose bracket

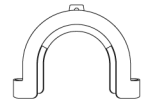

1x Warranty-card



5x Blanking plugs

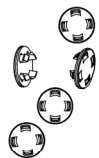

4x Noise reduction pads



1x Inlet hose assembly

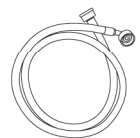

Cautions .....	3
Before Use .....	5
Functions .....	8
Maintenance .....	16
Trouble-Shooting .....	19
Technical data .....	20
After-Sale Service .....	21

## Legend



Yes



No



Optional



Warning! Important safety information!



General information and tips

## Disposal

The presence of this symbol on the product, accessories or materials that goes with this information indicates that at the end of its useful life the product or its electronic accessories should not be disposed with other household waste.



To prevent possible damage to the environment or human health from uncontrolled waste disposal, please separate these items from other types of waste and recycle them. This will promote the sustainable reuse of material resources.

Household users should contact either the retailer where they purchased the product or the relevant local authorities to find out how they can take this item for environmentally safe recycling and safety.

Business users should contact their supplier and check the conditions of the purchase. This product and its electronic accessories should not be mixed with other commercial waste.

## Before switching the appliance on for the first time

This appliance is not intended for use by persons (including children) with reduced physical, sensory or mental capabilities, or lack of experience and knowledge, unless they have been given supervision or instruction concerning use of the appliance by a person responsible for their safety.

Children should be supervised to ensure that they do not play with the appliance.

- Make sure that the transport bolt is removed.
- Use a separate earthed socket for the power supply.
- Make sure that the plug is accessible.
- Hold the plug and not the electric cable when unplugging the power supply.
- Make sure that the fuses in the power circuit are rated for 15A.
- Keep it away from heat sources and direct sunlight to prevent plastic and rubber components from aging.
- Make sure that the power cord is not caught under or in the appliance and avoid damage to the power cable.
- Check that hose joints and connections are firm and with no water leaking. If joints are not firm there will be leakage, turn off the water supply and refix it. Do not use the washing machine until the hoses are totally fixed.
- Make sure that the water pressure range is 0.03MPa-1MPa.
- If the power cord is damaged, it must be replaced by the manufacturer, its service agent or similarly qualified persons in order to avoid a hazard.
- This appliance incorporates an earth connection for functional purposes only.
  
- Do not touch or use the appliance when barefoot or with wet or damp hands or feet.
- Do not use flammable detergent or dry cleaning agent.
- Do not use any flammable sprays in close vicinity to the appliance.
- Do not remove or insert the plug in presence of flammable gas.
- Do not allow children or infirm persons to play with the appliance or packing materials.
- Do not install the appliance outdoors in a damp place, or in an area which may be prone to water leaks such as under or near a sink unit. In the event of a water leak allow the machine to dry naturally.
- Do not place the washing machine directly on a carpet, or close to a wall or furniture.
- This washing machine is not intended to be used in the following places:
  - staff kitchen areas in shops, offices and other working environments.
  - farm houses.
  - by clients in hotels, motels and other residential type environments.
  - bed and breakfast type environments.
  - areas for communal use in blocks of flats or in launderettes.

## During daily use of the appliance

- Pull up zips and fix loose threads to prevent the items from being entangled. If necessary, put small items into a small bag or net.
- Turn off the machine after each wash program and switch it off at the mains to save electricity, and for safety. Wipe clean the lower part of the porthole.
- Keep the door slightly open when the washing machine is not in use to prevent formation of odors.
- Use the hose-set supplied with the appliance. Old hose-sets should not be reused.
  
- Do not touch the washer door during the washing process, it gets hot.
- Do not place heavy objects or sources of heat or damp on top of the appliance.
- Do not hot wash from rubber or sponge-like materials.
- Do not open the detergent distribution drawer during the wash cycle.
- Do not force the washer door to open, the door is fitted with a self-lock device and will open after 2-3 minutes when the washing procedure is ended or the power is off.
- Do not open the washer door if the water level is visibly over the porthole.
- Do not cover the washing machine with a plastic cover so that the washing machine can dry out when not in use.

## Saving Tips

- ⓘ Achieve the best use of energy, water, detergent and time by using the recommended maximum load size.
- ⓘ Do not exceed the detergent dosages indicated in the manufacturer's instructions.
- ⓘ Save energy and time by selecting a high spin speed to reduce the water content in laundry before using a tumble dryer.
- ⓘ Choose the correct washing temperature. Modern detergents can wash with very good result at temperatures lower than 60°C.
- ⓘ Do not overload the washing machine:  
HWF70BW1 Max. load is 7kg.

## Description

This diagram may be slightly different from the layout of the washing machine you have just purchased.

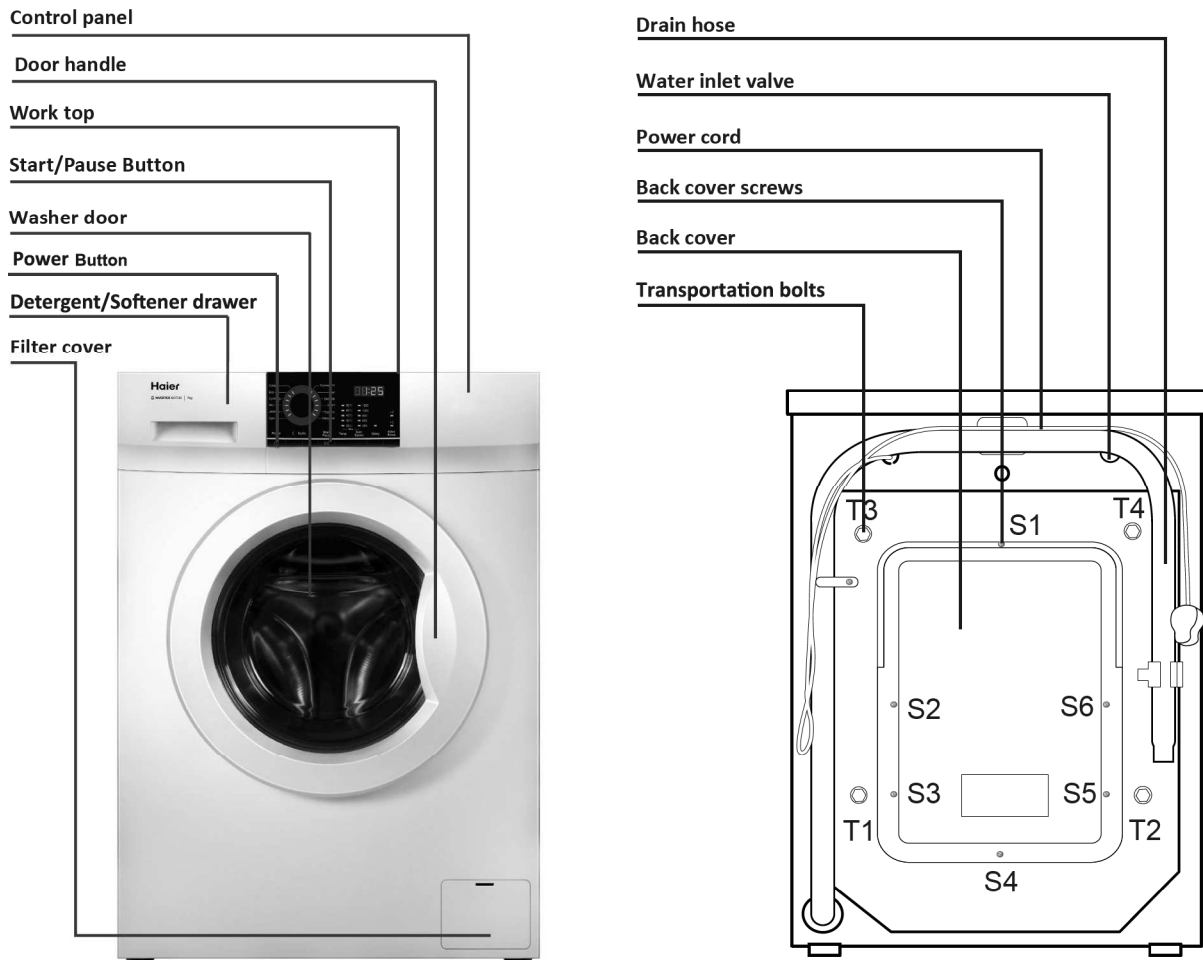

## Preparing the machine

Remove all the packing materials to prevent unsteadiness, including the polystyrene base. Upon opening the package, water drops may be seen on the plastic bag and the porthole. This is normal phenomenon resulting from water tests in the factory.

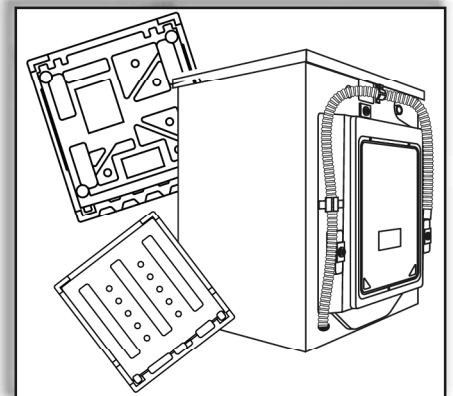

## Installation

### *Dismantle the transportation bolts*

The transportation bolts are designed for clamping anti-vibration components inside of the washing machine during the transportation process.

1. Remove the back cover.
2. Remove the four bolts on the rear side and take out the plastic stabilizers from within the machine.
3. Re-attach the back cover.
4. Fill the holes left by the bolts with blanking plugs.

#### Note:

- ⚠ When you re-attach the back cover, the convex must face to outside, and you have to insert the back cover from the two gaps as shown in fig.5.
- ⚠ Keep the transportation bolts and plastic stabilizers in a safe place for later use.

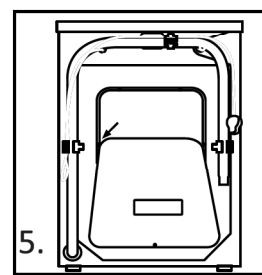
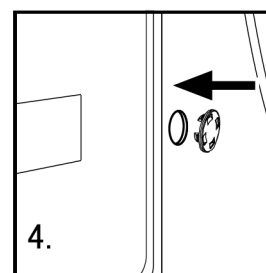
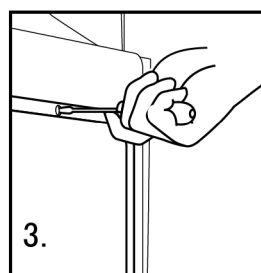
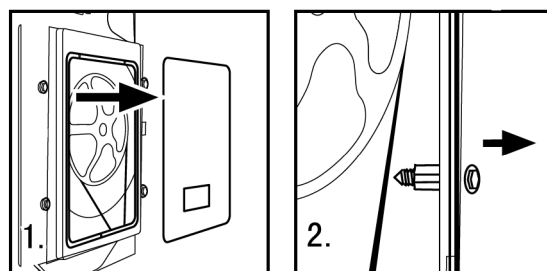

### *Adjusting the feet and locking nut*

There are adjustable feet under the bottom of the washing machine. Before use, they should be adjusted so that the machine is level. This will minimize vibrations and thus noise during use. It will also reduce wear and tear. We recommend to use a spirit level for adjustment. Floor should be as stable and flat as possible.

1. Loose the lock nut (1) by using a wrench.
2. Adjust the high by turning the foot (2).
3. Tighten the lock nut (1) against the housing.

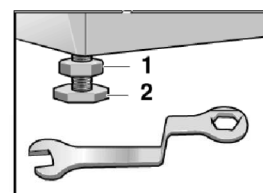

### *Install noise reduction pads(optional)*

When opening the shrink package, you will find four noise reduction pads.(Fig.1)

1. Lay the washing machine down to its side, porthole pointing upwards, bottom side towards operator.(Fig.2)
2. Take out the noise reduction pads and remove the double-sided adhesive protective film ; Paste around the bottom; The noise reduction pads under the washing machine cabinet as shown in Fig.3(two longer pads in position 1 and 3, two shorter pads in position 2 and 4). Finally set the machine upright again.

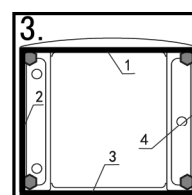
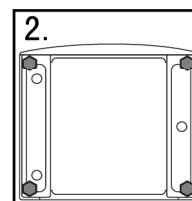
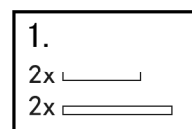

## Inlet Hose

- ✓ Connect the nut on the inlet hose to the connector on the water valve.
- ✓ Connect inlet hose to a water tap with cold, fresh water.

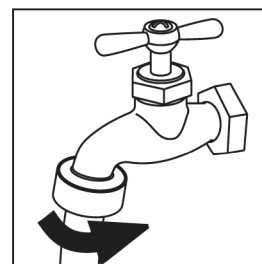
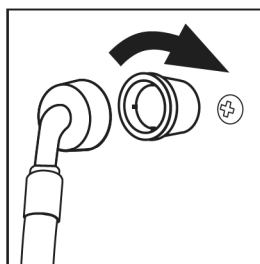

- ⚠ Use the hose-set supplied with the appliance. Old hose-sets should not be reused.

## Drain Hose

- ✓ Use the drain hose bracket to keep the end of the drain hose retained and prevent the outflow of water. Don't extend the length of the drain hose; if an extended hose is required, please consult a serviceman or plumber.
- ✓ The height of the drainage outlet must be 80-100 cm. Fix the drain hose to the clip at the back of the washing machine to prevent it from dropping off.

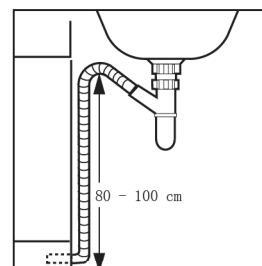
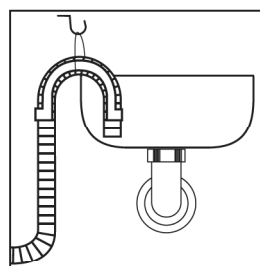

- ⚠ The drain hose should not be submerged in water and should be securely fixed and leak-free. If the drain hose is placed on the ground or if the pipe is at a height of less than 80cm, the washing machine will continuously drain while being filled (self-siphoning).

## Connecting to Power Supply

Before connecting to the power supply, check:

- ✓ The socket is adequate for the maximum power of the washing machine (For safety, fuses in the power circuit should be rated for no less than 15A).
- ✓ The voltage should meet the requirement on the rating plate.
- ✓ The power outlet should be capable of accepting the washing machine plug.
- ✓ Connect the machine to an earthed socket outlet.



# Functions



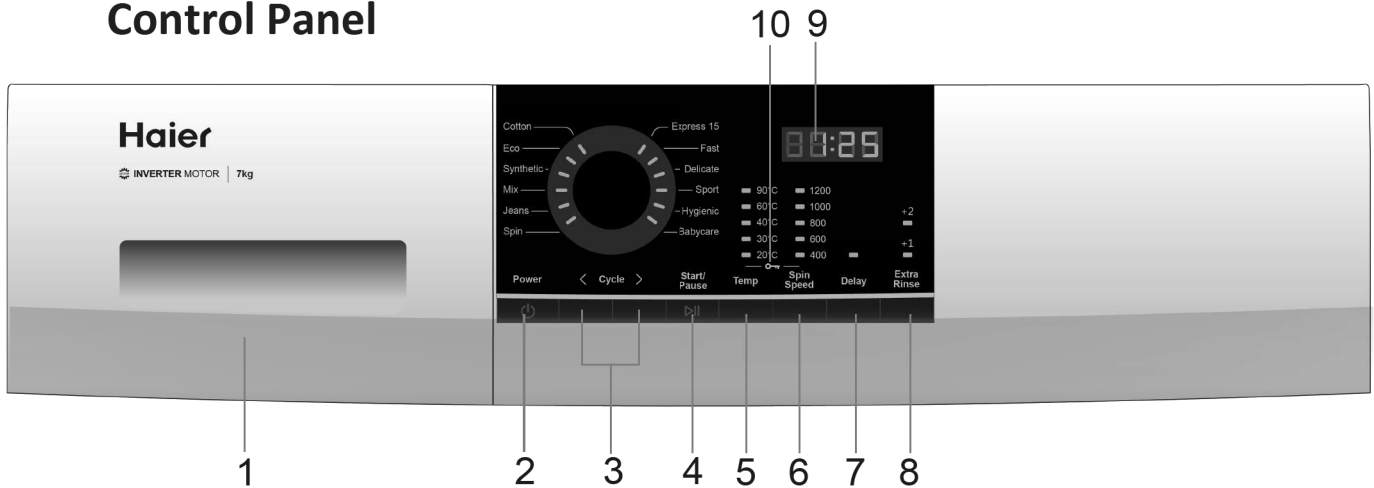

## Control Panel

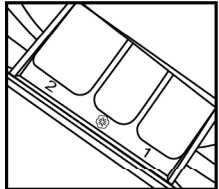

- |                              |                        |
|------------------------------|------------------------|
| 1. Detergent/Softener Drawer | 6. Spin Speed Button   |
| 2. Power Button              | 7. Delay Button        |
| 3. Cycle Buttons             | 8. Extra Rinse Button  |
| 4. Start/Pause Button        | 9. LED Display         |
| 5. Wash Temp                 | 10. Control Panel Lock |

## Operational Functions

Nº	Function	Explication	
1	<b>Detergent distribution drawer</b>	<p>Open the drawer, three compartments can be seen:            Compartment 1: Water inlet only, no detergent.            Compartment 2: Detergent for programs 1 to 11.            (Refer to page 10)            Compartment  :Softener, conditioning agent.</p> <p>The recommendation on the type of detergents is suitable for the various washing temperatures, please refer to the detergent packaging for dosage recommendations. Use low sudsing or front loader liquid or powder detergents. Alternatively use detergent pods.</p>	
2	<b>Power Button</b>	Press this button to switch on the washing machine. Press it again for 2 seconds to switch it off.	
3	<b>Cycle Buttons</b>	By press the two cycle button("<"、">"), the required program can be selected. There are 12 programs available. After a program is selected, the corresponding light will illuminate.	
4	<b>Start/Pause Button</b>	When the washing machine is connected to the power socket and a program is selected, press this button to start operation. During a wash cycle, press it lightly to pause the cycle, the information on the LED screen will start to blink. Press it again to resume operation. To cancel a wash program during the cycle, press the start/pause button and then press the power button.	
5	<b>Wash Temp</b>	Press this button, the corresponding washing temperature light will illuminate. Select a temperature according to the type of laundry. Note: If there is no indicator light displayed, this means cold wash.	

6	<b>Spin Speed</b>	<p>Press this button to select the desired speed. When a speed is set, its corresponding light will illuminate. Note: If there is no indicator light displayed, this means no spinning.</p> <p> Different water temperatures and spinning speeds can be set for different garments. Wash using the default settings if there is no special requirement.</p>
7	<b>Delay</b>	<p>Press this button to select a desired delay time. The options are from 30 min to 24 hours, in 30 minutes increments. After the delay time is set, press the Start/Pause button to start the countdown. Note that the delay function sets a time to finish the cycle rather than a time to start the cycle.</p> <p> The delay time must be longer than the program time otherwise the washing machine will start the wash program immediately.</p>
8	<b>Extra Rinse</b>	<p>Press this button to change the default number of rinses of the selected cycle. Press the button once to add one rinse and press the button twice to add two rinses. The corresponding light will illuminate. The light turns off when the extra rinse ends.</p> <p> You can select if you require this function when programs 1-11 are used. (Refer to page 10)</p>
9	<b>LED Display</b>	<p>Information as remaining wash time or error messages will be shown on the screen.</p> <p> After a wash program is started the display will go on and the remaining wash time decreases. As the water pressure and temperature may differ, the remaining time may be adjusted accordingly. When the laundry is not balanced during spinning, the running time may be automatically prolonged.</p>
10	<b>Control Panel Lock</b>	<p>Press the buttons "Temp" and "Spin Speed" simultaneously for 3 seconds to activate the lock function. This will inactivate all buttons in the control panel. For unlocking press again the two buttons. When the control panel lock is activated, the message "cLoT" will show on the screen if a button is pressed.</p>

## Program Modes

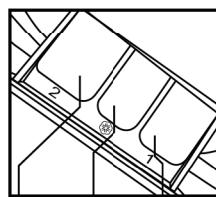

1 Water inlet only, no detergent.

2 Detergent compartment

☼ Compartment for softener

Program	Temp Max.	Temp Preset	2	3	1	Fabric Type	Spin Speed Preset	Spin Speed Max.
1 Cotton	90°C	30°C	✓	☉	✗	Cotton /Synth	1000 rpm	1200 rpm
2 Synthetic	60°C	30°C	✓	☉	✗	Chemical fibre fabrics	1000 rpm	1200 rpm
3 Mix	60°C	30°C	✓	☉	✗	Cotton /Synth	1000 rpm	1200 rpm
4 Eco	90°C	30°C	✓	☉	✗	Cotton	1000 rpm	1200 rpm
5 Delicate	30°C	30°C	✓	☉	✗	Delicate items	400 rpm	400 rpm
6 Sport	40°C	20°C	✓	☉	✗	Sports Wear	800 rpm	1000 rpm
7 Jeans	60°C	30°C	✓	☉	✗	Jeans	1000 rpm	1000 rpm
8 Hygienic	90°C	90°C	✓	☉	✗	Cotton	1000 rpm	1000 rpm
9 Fast	40°C	40°C	✓	☉	✗	Cotton	1000 rpm	1200 rpm
10 Express 15	40°C	---	✓	☉	✗	Cotton /Synth	1000 rpm	1200 rpm
11 Babycare	90°C	40°C	✓	☉	✗	Cotton /Synth	1000 rpm	1200 rpm
12 Spin	✗	✗	✗	✗	✗	All fabrics	1000 rpm	1200 rpm

Yes ✓

Optional ☉

No ✗

Water will not be heated ---

## Consumption Table

Program	Max. Load HWF70BW1	Temp	Washing Time
Cotton	7 kg	30°C	Auto
Synthetic	7 kg	30°C	Auto
Mix	7 kg	30°C	Auto
Eco	7 kg	30°C	Auto
Spin	7 kg	---	0:07
Sport	2 kg	20°C	0:25
Jeans	7 kg	30°C	1:12
Hygienic	4 kg	90°C	2:06
Fast	7 kg	40°C	0:57
Express 15	2 kg	---	0:15
Babycare	4 kg	40°C	Auto
Delicate	2 kg	30°C	0:51

⚠ The actual water temperature may differ from the declared cycle temperature.  
 If the machine is used for commercial purposes the warranty will be void. Do not use for purposes other than that which the machine is designed for. Follow the instructions given on the label of each garment and wash only machine-washable garments.

⚠ Energy Label Program Settings:  
 Eco, 40°C, 1200rpm is the program recommended for a normally soiled cotton load.  
 The detergent dosage: rated capacity\*12.5g\*70% and anti-foam aid is 14 g.  
 Detergent dissolvent method: Dissolve the detergent first and pour the dissolved detergent into the machine when the main wash starts.

## Washing Methods

 This washing machine is for domestic use only. If the machine is used for commercial purposes the guarantee will not be valid anymore. Do not use it for purposes other than that for which it was designed. Follow the instructions given on the label of each garment and wash only machine-washable garments.

## Power Supply

Connect the washing machine to the power supply (220V to 240V~/50Hz).

## Water Connection

Turn on the tap. The water must be clean and clear.

 Before use, check for leaks in the joints between the tap and the inlet hose by turning on the tap.

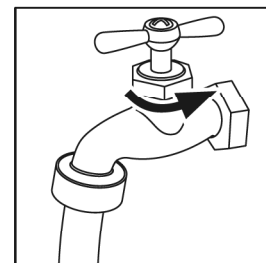

## Preparing the Laundry

Sort out clothes according to fabric (cotton, synthetics, wool, or silk, etc.) and to how dirty they are.

Separate white clothes from colored ones. Wash the colored clothes first by hand to check if they fade or run.

Empty pockets (keys, coins, etc.) and remove the harder decorative objects (e.g. brooches).

 Attention: Small parts (like buttons, etc.) may lead to repair work and can cause damage in the machine.

Garments without hems, underwear, and finely woven textile such as fine curtains are to be put into wash bag (it is better not to wash them in a washing machine).

Close zippers and hooks, make sure the buttons are sewn on tightly and place small items such as socks, belts, bras, etc. in the wash bag.

Unfold large pieces of fabric such as bedsheets, bedspreads, etc.

Turn shirts inside out.

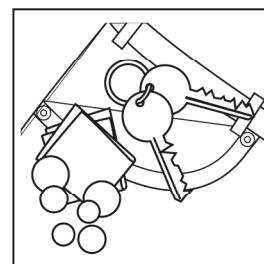
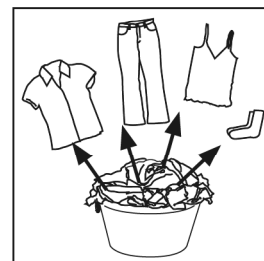

## Loading the appliance

Open the washer door put in the laundry piece by piece. Close the door tightly.

When using the machine for the first time, run it without a load but add detergent. Select the Cotton cycle and wash temperature 60°C, this will clean the drum and hoses before your first load.

Do not overload the washing machine. Note the different maximum load according to programs. Rule of thumb for maximum load: Keep six inches (approximately 15 cm) between load and drum top. Close the door carefully, making sure that there are no garments caught between the gasket and the door.





## Selecting Detergent



The washing efficiency and the performance is determined by the quality of detergent used. Special non-foaming detergent produces good washing results. Use specific detergents for synthetic and woollen goods. Do not use dry cleaning agents such as trichloroethylene and similar products.

 Do not add more detergent than needed as it may cause the machine to malfunction or impact the machine's life. It may also stain the clothes or leave residues.

Some situations that may arise from using too much detergent include:

-  Due to the increasing foam, the rinse time will be longer than normal.
-  The foam may overflow from the detergent drawer because of the increasing pressure of the foam.
-  It may remain foam without cleaning out after the final spinning cycle.

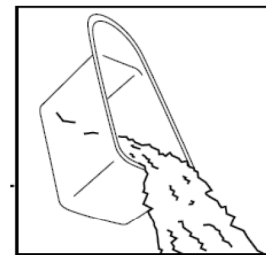

 Recommendation:

-  Clean the detergent drawer once a week.
-  Please follow the dosage recommendation on the powder or liquid detergent package.



## Adding Detergent

Slide out the detergent drawer and put the required detergent and softening agent into the corresponding compartments. Push back the drawer gently. (Refer to the instructions on the drawer)

-  Water inlet only, do not add detergent to compartment 1.
-  Use liquid detergent according to the instructions on its package. Do not use liquid detergent if the prewash mode or "Delay" is selected.
-  Do not overuse softener; otherwise, it will damage the artificial fibers.

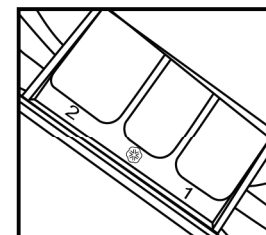

## *Selecting program*

To get the best washing results, an appropriate washing program should be selected according to the laundry type. Please press the two cycle buttons to select the right program.



## *Selecting function*

Select the required options. (Refer to the "Control panel" pages 8,9 and 10)

## *Setting washing temperature*

Press the Temp button to select the desired temperature.

## *Setting spin speed*

Press the Spin Speed button to select the desired speed. See "Operational functions" on the "Control panel" pages (8 and 9) for selecting temperature and spin speed. It is advisable to select the recommended value.

## *Washing*

Press the Start/Pause button. The washing machine will operate according to the preset programs. The washing machine will stop operation automatically when a washing cycle ends and "End" will appear on the display. Open the washer door and take out the garments after 2-3 minutes. When the washing machine is running, if the Start/Pause button is pressed, the washing machine will be in pause state. The door lock will still be activated for 2-3 minutes, the door can be open after this time if the opening conditions are met: water level below the porthole and adequate temperature.

## *After washing*

Turn off the water supply and unplug the power cord. Open the washer door to prevent formation of moisture and odors. Leave the door open while not used.

# Functions

## Care Chart

Machine Wash, COLD	Hand Wash	Tumble Dry, NO HEAT	Do Not Tumble Dry	Iron, Steam or Dry, with LOW HEAT
Machine Wash, WARM	Do Not Wash	Tumble Dry, LOW HEAT	Line Dry	Iron, Steam or Dry, with MEDIUM HEAT
Machine Wash, HOT	Bleach as needed Any bleach, like Clorox®, may be safely used	Tumble Dry, MEDIUM	Drip Dry	Iron, Steam or Dry, with HIGH HEAT
Machine Wash, COLD Permanent Press	Non-chlorine Bleach as needed Use only a color-safe bleach, like Clorox 2®	Tumble Dry, HIGH	Dry Flat	Do Not Iron with Steam
Machine Wash, WARM Permanent Press	Do Not Bleach No bleach product should be used including detergents with bleach - or follow bleach package test procedures to test for bleach safety.	Tumble Dry, Permanent Press, NO HEAT	Don't dry clean	Do Not Iron
Machine Wash, HOT Permanent Press		Tumble Dry, Permanent Press, LOW HEAT	Dry on clothes hanger	Dryclean May appear with additional letters and/or lines Take this item to a professional drycleaner
Machine Wash, COLD Gentle Cycle		Tumble Dry, Permanent Press, MEDIUM	Tumble dry, Medium heat	Do Not Dryclean
Machine Wash, WARM Gentle Cycle		Tumble Dry, Gentle Cycle, NO HEAT	Tumble dry, low heat	Dry cleaning with any solvent
Machine Wash, HOT Gentle Cycle		Tumble Dry, Gentle Cycle, LOW HEAT	Don't tumble dry	Dry cleaning with pericloride
Wool Mark		Tumble Dry, Gentle Cycle, MEDIUM		

## Load Reference

Material	Made of (normally)	Load in grams
Sheet	Cotton	Approximately 800
Blanket	Wool	Approximately 3000
Blended fabric clothes	Cotton or synth	Approximately 800
Jackets	Cotton	Approximately 800
Jeans	Cotton	Approximately 800
Overalls	Cotton	Approximately 950
Ladies Pyjamas	Cotton or synth	Approximately 200
Shirts	Cotton or synth	Approximately 300
Socks	Blended fabrics	Approximately 50
T-Shirts	Cotton	Approximately 300
Underwear	Blended fabrics	Approximately 70



## Cleaning and Care

### After washing

Turn off the water supply and remove the electrical plug after each wash. Open the washer door to prevent formation of moisture and odors. If the washing machine is left idle for a long period, drain the water in the machine and replace the drain hose.

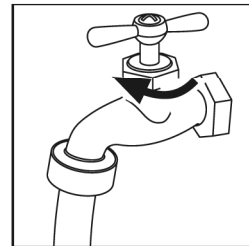

### Cleaning the detergent drawer

Take always care there are no detergent residues. Clean the drawer regularly :

1. Pull out the drawer until it stops.
2. Press the release button and remove the drawer.
3. Flush the drawer with water until it is clean and insert the drawer back in the appliance.

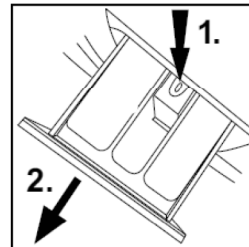

### Cleaning the machine

Unplug the machine during cleaning and maintenance. Use a soft cloth dampened with soap liquid to clean the machine case and rubber components. Do not use organic chemicals or corrosive solvents.

### Cleaning the filter

Clean the filter once a month:

1. Turn off and unplug the machine.
2. Open service flap. You can either use a coin or a screwdriver(Fig.1) .
3. Provide a flat container to catch leach water(Fig.2). There could be large amounts!
4. Pull the drainhose out and hold its end above the container (Fig.2).
5. Take the sealing plug out of the drainhose (Fig.3).
6. After complete drainage close drainhose, and push it back into the machine(Fig.4 and Fig.5).
7. Unscrew and remove counter clockwise the filter(Fig.6).
8. Remove contaminants and dirt (Fig.6).
9. Clean carefully pump filter, e.g. using running water(Fig.7).
10. Screw the filter back in place. Make sure it is tight to prevent leaks, but do not force it as it may break(Fig.8).
11. Close service flap.

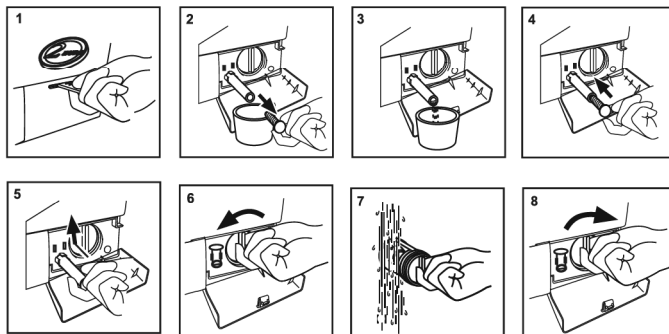

⚠ The filter must be in place, or it may lead to leakage.

⚠ Place a container under the drain pump filter, to collect any excess water that may come out of the drain pump.

### In case of power failure

The current programme and its setting will be saved. When power supply is restored operation will be resumed.

If a power failure cuts an operating wash programme the door may be open after 2-3 minutes.

To get out any garment water level should not be seen in the glassy porthole of the door.

- Danger of burns!

⚠ Power-off memory function: In case of abrupt power failure or the need to cut off the power during a program cycle, the present settings will be saved and the preset operation will resume when the power is on again.

## Water inlet valve and inlet valve filter

To prevent blockage to the water supply by ingress of foreign substances, clean the water inlet valve and inlet valve filter regularly.

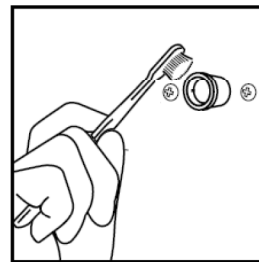

## Moving the machine

If the machine is to be moved to a distant location, replace the transportation bolts removed before installation to prevent damage as shown below.

Remove the back cover.

Remove the blanking plugs.

Insert the plastic stabilizers and the transportation bolts.

Tighten the bolts with a spanner.

Replace the back cover.

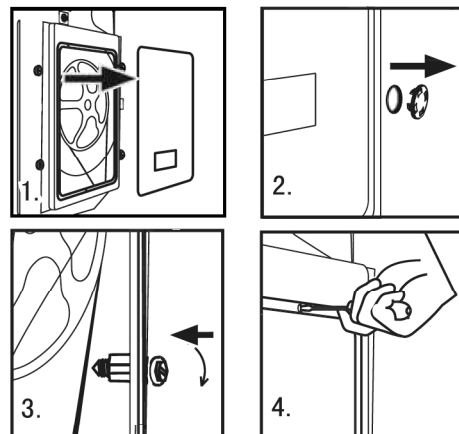

## Long periods of disuse

If the appliance is left idle for a longer period, pull out the electrical plug and turn off water supply. Open the door to prevent formation of moisture and odors.

Let door open while not used.

Before next usage check carefully power cord, water inlet and drain hose. Make sure everything is properly installed and without leakage.

## Display Codes

### Display Codes and Special functions

Codes	Causes	Solutions
E1r FL1r	Drainage error, water not emptied within 6 minutes.	Clean the pump filter and check the drain hose for blockage. If error still exists, please contact the maintenance personnel.
E2	Door is not properly shut.	Shut the door properly, and then press the Start/Pause button.
F3	Temperature sensor not properly connected or damaged.	Contact the maintenance personnel.
F4	Heater error (Appears at the end of a cycle).	Contact the maintenance personnel.
E4	Water level not met in 7 minutes. The height of the drain hose is below 80 cm. The drain hose is in water.	Make sure that tap is turned on, and water pressure is normal. If problem still exists, please contact the maintenance personnel. Install drain hose within 80-100 cm of height. Make sure the drain hose is not in water.

F7	Motor Error.	Contact the maintenance personnel.
E8	Water exceeds protective level.	Contact the maintenance personnel.
FA	Water level sensor error.	Contact the maintenance personnel.
FC1	Abnormal communication error display board and motor board.	Contact the maintenance personnel.
FC2	Abnormal communication error display board and power board	Contact the maintenance personnel.
End	End of wash cycle.	
19:30	Status information: Preset time for delayed operation.	
1:25	The remaining time is 1 hour 25 minutes.	
UNb	Washing machine has an unbalanced load protection function. When unbalanced weight is greater than allowable maximum, the washing machine will not spin and will run at a speed to avoid abnormal vibration and noise.	<ol style="list-style-type: none"> <li>1. In case washing 1 piece of laundry (carpet, bed sheet, table sheet, etc.) make it symmetrical inside the drum.</li> <li>2. Lower the wet weight of laundry pieces by wringing manually and placing them back in the drum in symmetrical position.</li> <li>3. Take out and then reposition the laundry pieces inside the washing machine in a more balanced position on the inner wall of the drum.</li> <li>4. Add 1 or 2 pieces of laundry into the drum to reduce the unbalanced load effects.</li> <li>5. Restart the spin cycle by closing spin program. In case the failure persists, please ask a qualified technician to repair it.</li> <li>6. Select a lower spin speed, and if OK then select Spin program and a higher spin speed.</li> </ol>

- ⓘ Power-off memory function: In case of abrupt power failure or the need to cut off the power during a program cycle, the present settings will be saved and the preset operation will resume when the power is on again.
- ⓘ To cancel a program. Press the "Start/Pause" button, then switch off the power and the program is automatically cancelled. Power on the machine and press the cycle buttons ("<"、">") to choose another program.
- ⚠ During the spin process, if too much foam is inspected, in order to protect the motor, the washing machine will eliminate the foam automatically; the motor will stop and the drain pump will drain the water continuously for 90 seconds. If it happens more than 3 times, the motor will stop until the end of cycle without spinning.

## Trouble-Shooting

Problem	Causes	Solutions
Washing machine fails to operate.	<ul style="list-style-type: none"> <li>✗ Poor connection to the power supply.</li> <li>✗ Power failure.</li> <li>✗ The washer door is not properly closed.</li> <li>✗ Machine has not been switched on.</li> </ul>	<ul style="list-style-type: none"> <li>✓ Check connection to the power supply.</li> <li>✓ Check the power supply.</li> <li>✓ Close the washer door properly.</li> <li>✓ Make sure the machine is switched on.</li> </ul>
Washing machine cannot be filled with water.	<ul style="list-style-type: none"> <li>✗ The "Start/Pause" button is not pressed.</li> <li>✗ Water tap is not turned on.</li> <li>✗ Water pressure is less than 0.03 MPa.</li> <li>✗ The inlet hose is kinked.</li> <li>✗ Water supply failure.</li> <li>✗ The program button is not properly set.</li> <li>✗ The washer door is not properly closed.</li> <li>✗ The inlet hose filter is blocked.</li> </ul>	<ul style="list-style-type: none"> <li>✓ Press the "Start/Pause" button.</li> <li>✓ Turn on the water tap.</li> <li>✓ Check water pressure.</li> <li>✓ Check the inlet hose.</li> <li>✓ Ensure the water supply.</li> <li>✓ Set the program button properly.</li> <li>✓ Close the washer door properly.</li> <li>✓ Unblock the inlet hose filter.</li> </ul>
Machine is draining while being filled.	<ul style="list-style-type: none"> <li>✗ The height of the drain hose is below 80 cm.</li> <li>✗ The drain hose is in water.</li> </ul>	<ul style="list-style-type: none"> <li>✓ Install drain hose within 80-100 cm of height.</li> <li>✓ Make sure the drain hose is not in water.</li> </ul>
Drainage failure.	<ul style="list-style-type: none"> <li>✗ Drain hose is blocked.</li> <li>✗ Drain hose end is higher than 100 cm above the floor level.</li> <li>✗ The filter is blocked.</li> </ul>	<ul style="list-style-type: none"> <li>✓ Unblock the drain hose.</li> <li>✓ Make sure the drain hose end is lower than 100 cm above floor level.</li> <li>✓ Unblock the filter.</li> </ul>
Strong vibration while spinning.	<ul style="list-style-type: none"> <li>✗ Not all transportation bolts have been removed.</li> <li>✗ Washing machine is located on an uneven surface or is not level.</li> <li>✗ Machine load is over 7kg.</li> </ul>	<ul style="list-style-type: none"> <li>✓ Remove all transportation bolts.</li> <li>✓ Make sure the washing machine is on an even surface and levelled.</li> <li>✓ Reduce amount of laundry in the drum.</li> </ul>
Operation stops before completing wash cycle.	<ul style="list-style-type: none"> <li>✗ Water or electricity failure.</li> </ul>	<ul style="list-style-type: none"> <li>✓ Check the power supply or water supply.</li> </ul>
Operation stops for a period of time.	<ul style="list-style-type: none"> <li>✗ Washing machine gives an error message.</li> <li>✗ Washing machine is in soaking cycle.</li> </ul>	<ul style="list-style-type: none"> <li>✓ Check display codes.</li> <li>✓ Press the rinse hold button or the Start/pause button again to cancel it.</li> </ul>
Excessive foam in the drum, which is spilled to the distribution drawer.	<ul style="list-style-type: none"> <li>✗ The detergent is not a low-foaming type or for manual wash.</li> <li>✗ Excessive use of detergent.</li> </ul>	<ul style="list-style-type: none"> <li>✓ Check if your detergent is appropriate.</li> <li>✓ Reduce amount of detergent in the distribution drawer.</li> </ul>
Automatic adjustment of the washing time.	<ul style="list-style-type: none"> <li>✗ The washing program duration will be adjusted.</li> </ul>	<ul style="list-style-type: none"> <li>✓ This is normal and doesn't affect the functionality.</li> </ul>
Spinning fails.	<ul style="list-style-type: none"> <li>✗ Unbalance of the laundry.</li> </ul>	<ul style="list-style-type: none"> <li>✓ Add clothes or run a spinning program again.</li> </ul>

Basic technical information regarding the appliance.

## HWF70BW1

Power source	220 - 240V~/50Hz
Max. working current (A)	10
Water pressure (MPa)	$0.03 \leq P \leq 1$
Nominal load (kg)	7.0
Max. spinning speed (rpm)	1200
Washing programs	12
Max. power (W)	1900
Dimensions (HxDxW mm)	850 x 550 x 595
Net weight (kg)	70

If after checking the trouble-shooting part, the problem is not solved. Please check the Warranty Card included in the product.

### DISPOSAL

The presence of this symbol on the product, accessories or materials that goes with this information indicates that at the end of its useful life the product or its electronic accessories should not be disposed with other household waste.

To prevent possible damage to the environment or human health from uncontrolled waste disposal, please separate these items from other types of waste and recycle them.

This will promote the sustainable reuse of material resources. Household users should contact either the retailer where they purchased the product or relevant local authorities to find out how they can take this item for environmentally safe recycling and safety.

Business users should contact their supplier and check the conditions of the purchase. This product and its electronic accessories should not be mixed with other commercial waste.



