

Haier

User Manual

Refrigerator-Freezer

HRF510BHC

HRF510BW

HRF510BS

HRF510FHC

HRF510FHS

HRF510FS



<u>4 Intended use</u>	•	
<u>5 Safety information</u>	•	
		<u>Before first use</u> 5
		<u>Installation</u> 6
		<u>Daily use</u> 6
<u>9 Product description</u>	•	
<u>13 Control panel</u>	•	
<u>14 Use</u>	•	<u>Adjust the temperature for fridge</u> 15
		<u>Adjust the temperature for freezer</u> 15
		<u>Super-Cool function</u> 16
		<u>Super-Frz function</u> 16
<u>21 Equipment</u>	•	
<u>23 Energy saving tips</u>	•	
<u>24 Care and cleaning</u>	•	
<u>27 Troubleshooting</u>	•	
<u>31 Installation</u>	•	
<u>36 Technical data</u>	•	

Thank you for purchasing a Haier Product.

Please read these instructions carefully before using this appliance. The instructions contain important information which will help you get the best out of the appliance and ensure safe and proper installation, use and maintenance.

Keep this manual in a convenient place so you can always refer to it for the safe and proper use of the appliance.

If you sell the appliance, give it away, or leave it behind when you move house, make sure you also pass this manual so that the new owner can become familiar with the appliance and safety warnings.



WARNING – Important Safety information



NOTICE-General information and tips



Environmental information



Disposal

Help protect the environment and human health. Put the packaging in applicable containers to recycle it. Help to recycle waste of electrical and electronic appliances. Do not dispose appliances marked with this symbol with the household waste. Return the product to your local recycling facility or contact your municipal office.



WARNING!

Risk of injury or suffocation!

Refrigerants and gases must be disposed of professionally. Ensure that the tubing of the refrigerant circuit is not damaged before being properly disposed of. Disconnect the appliance from the mains supply. Cut off the mains cable and dispose of it. Remove the trays and drawers as well as the door catch and seals, to prevent children and pets to get closed in the appliance.

Accessories

Check the accessories and literature in accordance with this list:

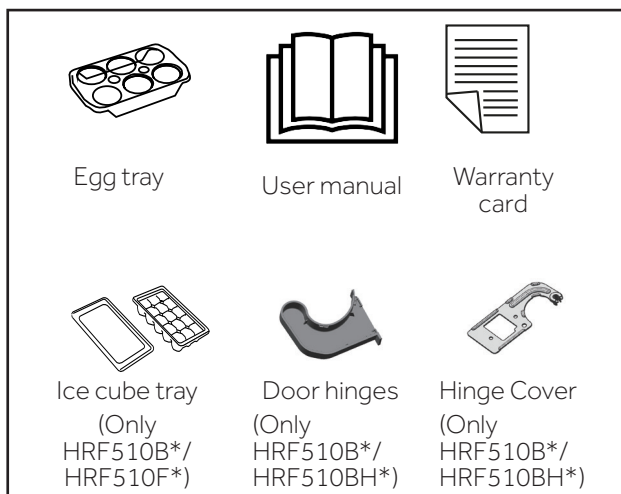

Intended use

This appliance is intended to be used in household and similar applications such as

- staff kitchen areas in shops, offices and other working environments;
- farm houses and by clients in hotels, motels and other residential type environments;
- bed and breakfast type environments;
- catering and similar non-retail applications.

Before switching on the appliance for the first time read the following safety hints:



WARNING!

Before first use

- ▶ Make sure there is no transport damage.
- ▶ Remove all packaging and keep out of children's reach.
- ▶ Wait at least two hours before installing the appliance in order to ensure the refrigerant circuit is fully efficient.
- ▶ Install the appliance in direct sunlight or near sources of heat (eg stoves, heaters)
- ▶ Use multi-plug adapters and extension cables.
- ▶ If it does become damaged, do not
- ▶ Handle the appliance always with at least two persons because it is heavy.

Installation

- ▶ The appliance should be placed in a well-ventilated place. Ensure a space of at least 5 cm above and around the appliance.
- ▶ Never place the appliance in a damp area or location where it might be splashed with water. Clean and dry water splashes and stains with a soft clean cloth.
- ▶ Do not install the appliance in direct sunlight or in the near of heat sources (e.g. stoves, heaters).
- ▶ Install and level the appliance in an area suitable for its size and use.
- ▶ Keep ventilation openings in the appliance or in the in-built structure clear of obstruction.
- ▶ Make sure that the electrical information on the rating plate agrees with the power supply. If it does not, contact an electrician.
- ▶ The appliance is operated by a 220-240 VAC/50 Hz power supply. Abnormal voltage fluctuation may cause the appliance to fail to start, or damage to the temperature control or compressor, or there may be an abnormal noise when operating. In such case, an automatic regulator shall be mounted.
- ▶ Do not use multi-plug adapters and extension cables.
- ▶ Do not locate multiple portable socket-outlets or portable power supplies at the rear of the appliance.
- ▶ Ensure that the power cable is not trapped by the refrigerator. Do not step on the power cable
- ▶ Make sure not to damage the electric cable and the plug. If damaged it must only be re-placed by either the manufacturer or the authorised service agent.



WARNING!

- ▶ Use a separate earthed socket for the power supply which is easy accessible. The appliance must be earthed.
Only for UK: The appliance's power cable is fitted with 3-cord (grounding) plug that fits a standard 3-cord (grounded) socket. Never cut off or dismount the third pin (grounding). After the appliance is installed, the plug should be accessible.
- ▶ Do not damage the refrigerant circuit.

Daily use

- ▶ This appliance can be used by children aged from 8 years and above and persons with reduced physical, sensory or mental capabilities or lack of experience and knowledge if they have been given supervision or instruction concerning use of the appliance in a safe way and understand the hazards involved.
- ▶ Children aged from 3 to 8 years are allowed to load and unload, but not allowed to clean or install the refrigerating appliances.
- ▶ Keep away children under 3 years of age from the appliance unless they are constantly supervised.
- ▶ Children shall not play with the appliance.
- ▶ If cool gas or other inflammable gas is leaking in the vicinity of the appliance, turn off the valve of the leaking gas, open the doors and windows and do not unplug a plug in the power cable of the refrigerator or any other appliance.
- ▶ Notice that the appliance is set for operation at a specific ambient range between 10 and 43°C. The appliance may not work properly if it is left for a long period at a temperature above or below the indicated range.
- ▶ Do not place unstable articles (heavy objects, containers filled with water) on top of the refrigerator, to avoid personal injury caused by falling or electric shock caused by contact with water.
- ▶ Do not pull on the door shelves. The door may be pulled slant, the bottle rack, may be pulled away, or the appliance may topple.
- ▶ Open and close the doors only with the handles. The gap between the doors and between the doors and the cabinet is very narrow. Do not extend your hands in these areas to avoid pinching your fingers. Open or close the refrigerator doors only when there are no children standing within the range of door movement.

**WARNING!**

- ▶ Do not store or use inflammable, explosive or corrosive materials in the appliance or in the vicinity.
 - ▶ Do not store medicines, bacteria or chemical agents in the appliance. This appliance is a household appliance. It is not recommended to store materials that require strict temperatures.
 - ▶ Never store liquids in bottles or cans (besides high percentage spirits) especially carbonated beverages in the freezer, as these will burst during freezing.
 - ▶ Check the condition of food if a warming in the freezer has taken place.
 - ▶ Do not set unnecessarily low temperature in the refrigerator compartment. Minus temperatures may occur at high settings. Attention: Bottles can burst
 - ▶ Do not touch frozen goods with wet hands (wear gloves). Especially do not eat ice lollies immediately after removal from the freezer compartment. There is the risk to freeze or the formation of frost blisters. FIRST aid: keep immediately under running cold water. Do not pull away!
 - ▶ Do not touch the inside surface of the freezer storage compartment when in operation, especially with wet hands, as your hands may freeze onto the surface.
 - ▶ Unplug the appliance in the event of a power interruption or before cleaning. Allow at least 7 minutes before restarting the appliance, as frequent starting may damage the compressor.
 - ▶ Do not use electrical devices inside the food storage compartments of the appliance, unless they are of the type recommended by the manufacturer.
- Maintenance / cleaning
- ▶ Make sure children are supervised if they carry out cleaning and maintenance.
 - ▶ Disconnect the appliance from the electrical supply before undertaking any routine maintenance. Allow at least 5 minutes before restarting the appliance, as frequent starting may damage the compressor.



WARNING!

- ▶ Hold the plug, not the cable, when unplugging the appliance.
- ▶ Do not clean the appliance with hard brushes, wire brushes, detergent powder, petrol, amyl acetate, acetone and similar organic solutions, acid or alkaline solutions. Please clean with special refrigerator detergent to avoid damage.
- ▶ Do not scrape off frost and ice with sharp objects. Do not use sprays, electric heaters like heater, hair dryer, steam cleaners or other sources of heat in order to avoid damage to the plastic parts.
- ▶ Do not use mechanical devices or other means to accelerate the defrosting process, other than those recommended by the manufacturer.
- ▶ If the supply cord is damaged, it must be replaced by the manufacturer, its service agent or similarly qualified persons in order to avoid a hazard.
- ▶ Do not try to repair, disassemble or modify the appliance by yourself. In case of repair please contact our customer service.
- ▶ Eliminate the dust on the back of the unit at least once in the year to avoid hazard by fire, as well as increased energy consumption.
- ▶ Do not spray or flush the appliance during cleaning.
- ▶ Do not use water spray or steam to clean the appliance.
- ▶ Do not clean the cold glass shelves with hot water. Sudden temperature change may cause the glass to break.

Refrigerant gas information



WARNING!

The appliance contains the flammable refrigerant ISOBUTANE (R600a). Make sure the refrigerant circuit is not damaged during transportation or installation. Leaking refrigerant may cause eye injuries or ignite. If a damage has occurred, keep away open fire sources, thoroughly ventilate the room, do not plug or unplug the power cords of the appliance or any other appliance. Inform the customer service.

In case of eyes get into contact with the refrigerant, rinse immediately it under running water and call immediately the eye specialist.

This product contains flammable refrigerant isobutane (R600aa).

It is hazardous for anyone other than an Authorised Service Person to service this appliance. In Queensland-the authorized Service Person MUST hold a Gas Work Authorisation for hydrocarbon refrigerants, to carry out Servicing or repairs which involve the removal of covers.



WARNING: Risk of fire/flammable material

The symbol indicates there is a risk of fire since flammable materials are used. Take care to avoid causing a fire by igniting flammable material.

i NOTICE

Due to technical changes and different models, some of the illustrations in this manual may differ from model.

(HRF510B*)

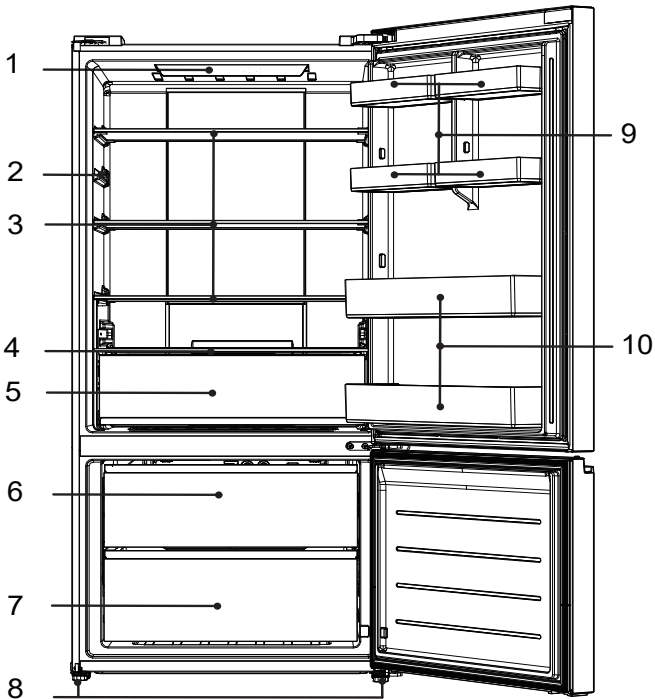

1-Control panel

2-Rating plate

3-Cabinet shelf

4-Fresh Storage bin cover

5-Fresh Storage bin

6-Upper freezer storage drawer

7-Lower freezer storage drawer

8-Adjustable feet

9-Adjustable door shelf

10-Full-width door shelf



NOTICE

Due to technical changes and different models, some of the illustrations in this manual may differ from model.

(HRF510BH*)

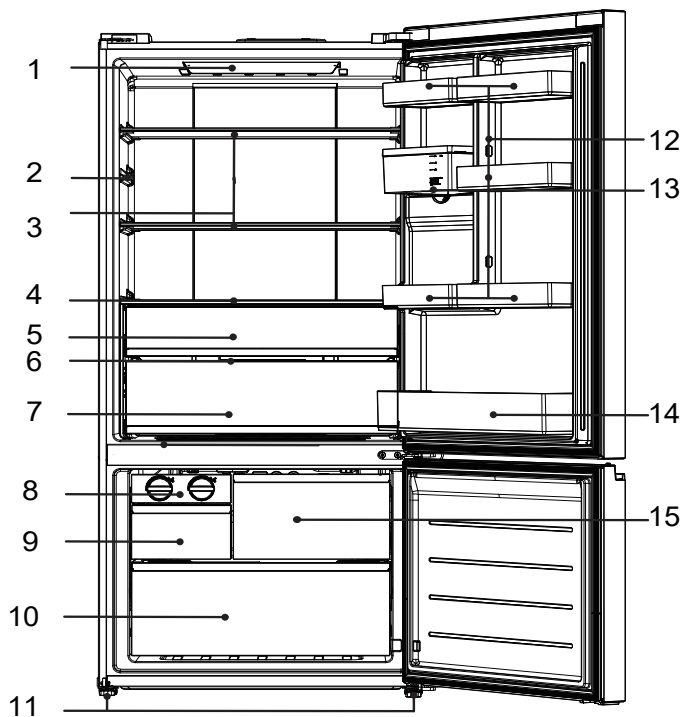

1-Control panel

2-Rating plate

3-Cabinet shelf

4-Fresh Storage bin cover

5-Fresh Storage bin

6-Humidity bin cover

7-Humidity bin

8-Twist ice maker

9-Ice storage drawer

10-Lower freezer storage drawer

11-Adjustable feet

12-Adjustable door shelf

13-Water tank

14-Full-width door shelf

15-Upper freezer storage drawer

i NOTICE

Due to technical changes and different models, some of the illustrations in this manual may differ from model.

(HRF510F*)

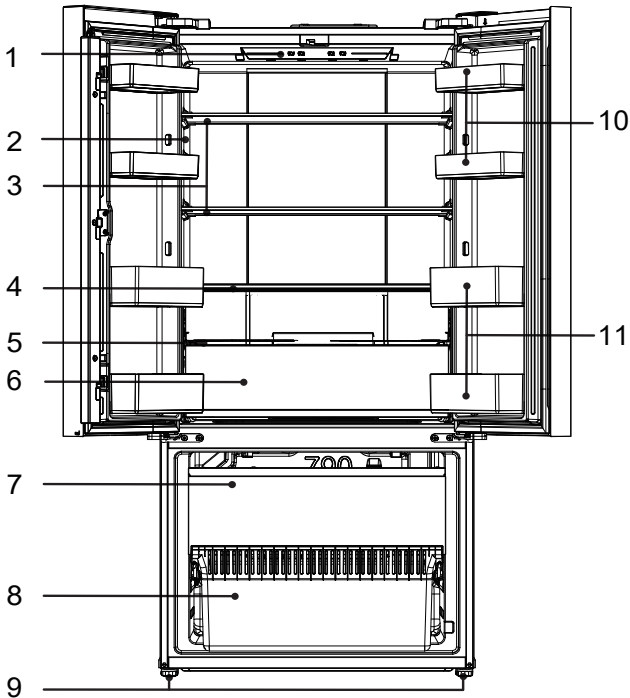

1-Control panel

2-Rating plate

3-Cabinet shelf

4-Cabinet shelf

5-Humidity bin cover

6-Humidity bin

7-Upper freezer storage drawer

8-Lower freezer storage drawer

9-Adjustable feet

10-Adjustable door shelf

11-Full-width door shelf



NOTICE

Due to technical changes and different models, some of the illustrations in this manual may differ from model.

(HRF510FH*)

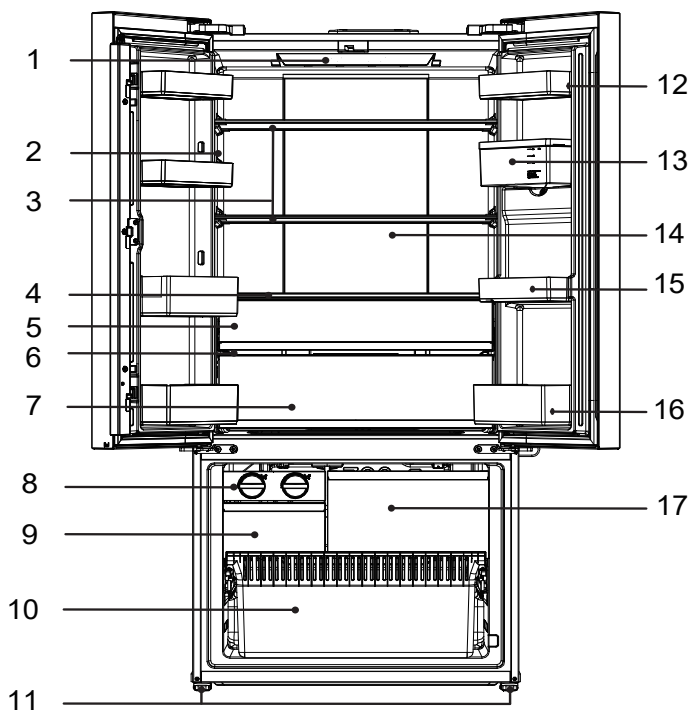

1-Control panel

2-Rating plate

3-Cabinet shelf

4-Fresh Storage bin cover

5-Fresh Storage bin

6-Humidity bin cover

7-Humidity bin

8-Twist ice maker

9-Ice storage drawer

10-Lower freezer storage drawer

11-Adjustable feet

12-Adjustable door shelf

13-Water tank

14-Fridge compartment light

15-Small-width door shelf

16-Full-width door shelf

17-Upper freezer storage drawer

Control panel

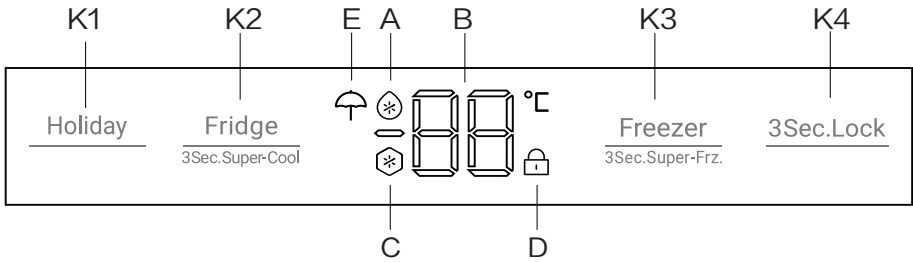

Indicators:

- A Super Cool function
- B Temperature display
Fridge/Freezer
- C Super Freeze function
- D Panel lock function
- E Holiday Function

Buttons:

- K1 Holiday selector
- K2 Fridge selector /Super cool function selector (Press 3 seconds),
- K3 Freezer selector /Super freeze function selector (Press 3 seconds),
- K4 Panel lock selector

Before first use

Remove all packaging materials, keep them out of children's reach and dispose them in an environment friendly way.

Clean the inside and outside of the appliance as well as the interior and accessories with water and a mild detergent, and dry it well with soft cloth.

After the appliance has been levelled and cleaned, please wait for at least 2 hours before connecting it to the power supply. See Section INSTALLATION.

Precool the compartments at high settings before loading with food. The function Super Freeze helps to cool down the freezer compartment quickly

The refrigerator temperature and freezer temperature are automatically set to 5°C and -18°C respectively. These are the recommended settings. If desired, you can change these temperatures manually. Please see FUNCTIONS

Sensor keys

The buttons on the control panel are sensor keys, which already respond when lightly touched with the finger.

Switch on /off the appliance

The appliance is in operation as soon as it is connected to the power supply.

When the appliance is powered on for the first time, temperature indicators "B" shows the presetting values (refer to the below Notice).



NOTICE

The appliance is preset to the recommended temperature of 5 °C (refrigerator) and -18 °C (freezer). These are the recommended settings. If desired, you can change these temperatures manually.

Lock/unlock panel

- ▶ Touch button "K4" for 3 seconds to block all panel elements against activation. The related indicator "D" is now displayed.
- ▶ For unlocking the control panel, press the button for 3 seconds again.

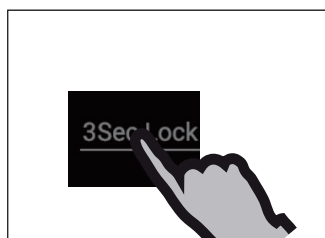

Door opening alarm

When the refrigerator door is open for more than 3 minutes, the door opening alarm will sound.

The alarm can be silenced by closing the door. If the door is open for more than 7 minutes, the light inside the refrigerator and control panel illumination will automatically turn off.

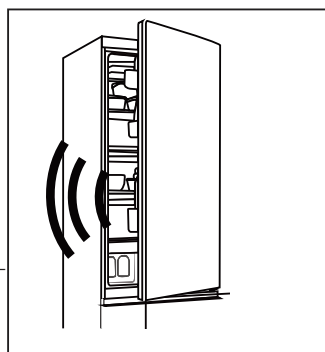

Adjust the temperature

The indoor temperatures are influenced by the following factors:

- ▶ Ambient temperature
- ▶ Frequency of door opening
- ▶ Amount of stored foods
- ▶ Installation of the appliance

Adjust the temperature for fridge

1. Unlock the panel if it is locked.
2. Press the button "K2" (Fridge) to select the Fridge compartment. Indicator "B" is flashing.
3. Press the button "K2" to set the fridge temperature.

The temperature reduce in sequences of 1°C, from a maximum of 9°C to a minimum of 1°C. switching to 9°C again when pressing further.

The optimum temperature in the refrigerator is 5°C. Colder temperatures mean unnecessary energy consumption.

4. Press any key except "K2" to confirm, or the setting confirms automatically after 5 seconds. Indicator "B" stops flashing.

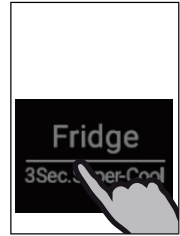

Adjust the temperature for freezer

1. Unlock the panel if it is locked.
2. Press the button "K3" (Freezer) to select the Freezer compartment. Indicator "B" is flashing.
3. Press the button "K3" (Freezer) to set the freezer temperature.

The temperature reduce in sequences of 1°C, from a maximum of -14°C to a minimum of -24°C. switching to -14°C again when pressing further.

The optimum temperature in the refrigerator is -18°C. Colder temperatures mean unnecessary energy consumption.

4. Press any key except "K3" to confirm, or the setting confirms automatically after 5 seconds. Indicator "B" stops flashing.



NOTICE

After setting the temperature, if other buttons are pressed within 5 seconds, the current temperature setting will be confirmed immediately. If no button operation is performed within 5 seconds, the current set temperature is displayed until the screen extinguishes.

Super cool function

Switch on the Super cool function if larger quantity of food should be stored (forexample after the purchase). The Super cool function accelerates the cooling of fresh food and protects the goods already stored from undesirable warming. The factory setting temperature is + 1 °C.

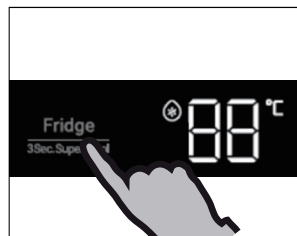

1. Unlock the panel if it is locked.
2. Press button "K2"(Fridge) for 3 seconds Indicator "A" illuminates and the function is activated.
3. The same operation can exit super cool function.



NOTICE

This function will be automatically disabled after 3 hours.

Super freeze function

Fresh food should be frozen as quickly as possible to the core. This preserved the best nutritional value, appearance and taste. The Super freeze function accelerates the freezing of fresh food and protects the goods already stored from undesirable warming. If you need to freeze a large amount of food once, it is recommended to set the Super-freeze function on ahead for 24h before the usage of Freezer compartment

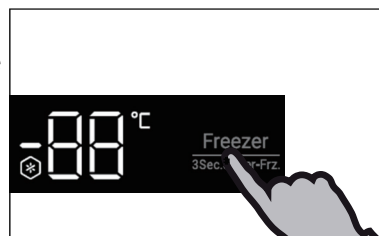

1. Unlock the panel if it is locked.
2. Press button "K3"(Freeze) for 3 seconds Indicator "B" illuminates and the function is activated.
3. The same operation can exit super freeze function.

Holiday function

This function sets the refrigerator temperature permanently to 17°C.

This allows to keep the door of the empty refrigerator closed without causing an odour or mold - during a long absence (e.g. during holiday). The freezer compartment is free for your setting.

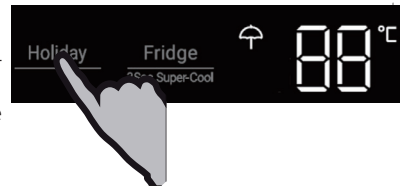

1. Unlock the panel if it is locked.
2. Press button "K1"(Holiday)
3. Indicator illuminates and the function is activated.
4. The function can be deactivated by pressing button K1(Holiday) again or by setting the refrigerator temperature or by performing any other setting



WARNING!

During the holiday function no goods must be stored in the refrigerator compartment.

The temperature of + 17°C is too high for storing food.

Water dispenser

(Only HRF510BH*/HRF510FH*)

With the water dispenser cool drinking water can be tapped

The water tank should be cleaned before first use (see CARE AND CLNING).

Filling the water tank



WARNING!

Use drinking water only.

1. Ensure that the water tank is properly inserted (see EQUIPMENT)
2. Rotate and lift the round lid (A) and fill the water tank up with fresh drinking water.
3. Fill water only up to the mark (2 L); as it could overflow when the door opens and closes.

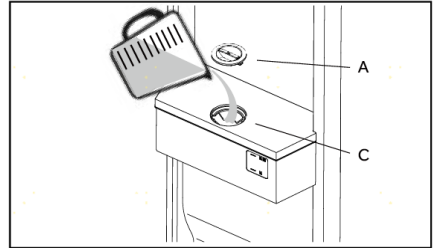

NOTICE

- ▶ Before refilling dispose residual water and clean the water tank
- ▶ When you don't need water for a long time, please empty the water tank and insert the cleaned tank.
- ▶ The cover (C) on the water tank is additionally used to save energy. If you do not want to get water from the water dispenser for a long period, please still install the cover because of better insulating and saving energy.

Getting water from the dispenser

1. Place a glass underneath the water outlet.
2. Push it gently against the water dispenser lever with your glass.
Make sure the glass is in line with the dispenser to prevent the water from splashing out.

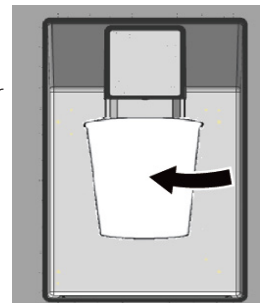

Storing into the refrigerator compartment

- Keep your fridge temperature below 5°C.
- Hot food must be cooled to room temperature before storing in the appliance.
- Foods stored in the refrigerator should be washed and dried before storing.
- Food to be stored should be properly sealed to avoid odor or taste alterations.
- Do not store excessive quantities of food. Leave spaces between foods to allow cold air flowing around them, for a better and more homogeneous cooling.
- Foods eaten daily should be stored at the front of the shelf.
- Leave a gap between foods and the inner walls, allowing air flowing. In any way, don't store foods against the rear wall: foods could freeze against the rear wall. Avoid direct contact of food (especially oily or acidic food) with the inner liner, as oil/acid can erode the inner liner. Clean away oily/acid dirt whenever it is found.
- Frozen food can be gently defrizzed in the refrigerator compartment. This saves energy.
- The ageing process of fruit and vegetables such as courgettes, melons, papaya, bananas, pineapples, etc. can be accelerated in the refrigerator. Therefore, it is not recommended to store them in the refrigerator. However, the ripening of strongly green fruits can be promoted for a certain period. Onions, garlic, ginger and other root vegetables should also be stored at room temperature.
- Unpleasant odours inside the fridge are a sign that something has spilled and cleaning is required. See Care And Cleaning.
- Different foods should be placed in different areas according to their properties.

Storage into the freezer compartment

- Keep the freezer temperature at -18°C.
- 24 hours before freezing, switch on the Super-Freezing function. For little quantities of food, 4-6 hours are sufficient.
- Hot food must be cooled to room temperature before storing in the freezer compartment.
- Food cut into small portions will freeze faster and be easier to defrost and cook. The recommended weight for each portion is less than 2.5 kg.
- It is better to pack food before putting it into the freezer. The outside of the packaging must be dry to avoid bags sticking together. Packaging materials should be odour-free, airtight, non-poisonous and nontoxic.
- In order to avoid expiration of storage periods, please note the freezing date, time limit and name of the food on the packaging according to the storage periods of different foods.



WARNING!

- ▶ Acid, alkali and salt etc. could erode the internal surface of the freezer.
- ▶ Do not place the food with these substances (e.g. sea fish) directly on the internal surface. Salt water in the freezer should be cleaned up immediately.
- ▶ Do not exceed the food storage time recommended by the manufacturers. Only take the required amount of food out of the freezer.
- ▶ Consume defrosted food quickly. Defrosted food cannot be re-frozen unless it is first cooked, otherwise it may be less edible.
- ▶ Do not load excessive quantities of fresh food in the freezer compartment. Refer to the freezing capacity of the freezer - See TECHNICAL DATA or data at the type plate.
- ▶ Food can be stored in the freezer at a temperature of at least -18°C for 2 to 12 months, depending on its properties (e.g. meat: 3-12 months, vegetables: 6-12 months)
- ▶ While freezing fresh food, avoid bringing them in contact with already frozen food. Risk of thawing!

When storing commercially frozen foods, please follow these guidelines:

- Always follow manufacturers' guidelines for the length of time you should store food for. Do not exceed these guidelines!
- Try to keep the length of time between purchase and storage as short as possible to preserve food quality.
- Buy frozen food, which have been stored at a temperature of -18°C or below.
- Avoid buying food which has ice or frost on the packaging - This indicates that the products might have been partially defrosted and refrozen at some point-temperature rising affects the quality of food.

i NOTICE

Due to different models, your product may not have all of the following features. Please refer to chapter Product Description.I.

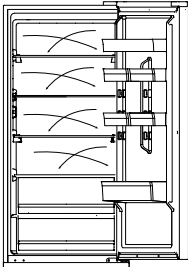

Multi-air-flow

The refrigerator is equipped with a multi-air-flow system, with which cool air flows are located on every shelf level. This helps to maintain a uniform temperature to ensure that your food is kept fresher for longer.

Adjustable shelf

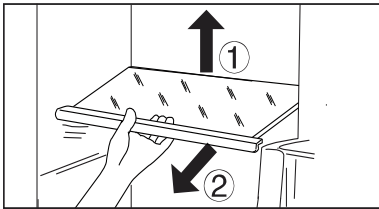

1. The height of the shelves can be adjusted to fit your storage needs.
2. To relocate a shelf, remove it first by uplifting its hind edge ① and pulling it out ②.
3. To reinstall it, put it on the lugs on both sides and push it to the most rearward position until the rear of the shelf is fixed inside the slots in the sides

i NOTICE

Ensure that all ends of a shelf are level.

Removable door shelf

The door balcony can be removed for cleaning:

Place hands on each side of the balcony, lift it upwards (1) and pull it out (2). In order to insert the door balcony, the above steps are carried out in a reverse order.

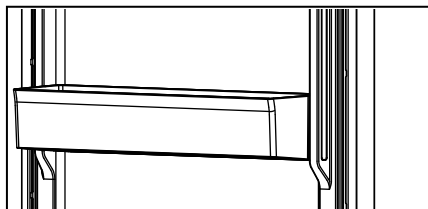

Humidity Zone drawer

In this compartment the humidity level is controlled automatically by the system and it is suitable to store fruits, vegetables, salads etc.

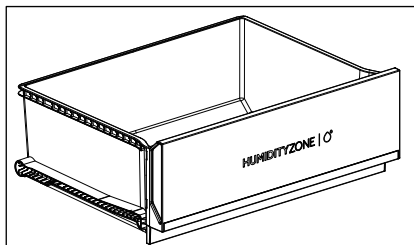

Removable drawer

To remove the drawer out of the fridge or freezer compartment, pull out to the maximum extent (1), lift and remove (2).

In order to insert the drawer, the above steps are carried out in a reverse order.

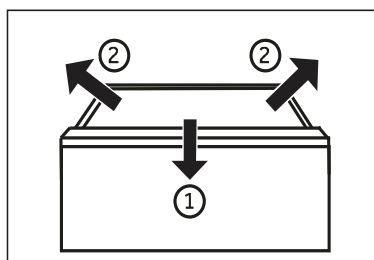

Freezer drawer

The freezer drawer can be extended straightly and completely. They are mounted on easy roll telescopic rail. So that you can store and remove the freezing good comfortably. Because of the automatic door closing mechanism, the handling is easy and you can save energy.



WARNING!

Do not overload the drawers: Maximum load of each drawer: 35kg!

Removable water tank (Only models with water dispenser)

The water tank can be removed and reinstalled

Insert water tank (Only models with water dispenser)

Place the water tank in the position that the water outlet (B) fits into the opening of the

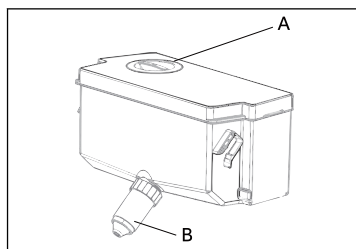



Energy saving tips

- ▶ Make sure the appliance is properly ventilated (see INSTALLATION).
- ▶ Do not install the appliance in direct sunlight or near the heat sources (eg. stoves, heaters).
- ▶ Avoid unnecessarily low temperature in the appliance. The energy consumption increases with the decreasing of the setting temperature in the appliance.
- ▶ Functions like SUPER FREEZE consume more energy.
- ▶ Allow warm food to cool down before placing it in the appliance.
- ▶ Open the appliance door as little and briefly as possible.
- ▶ Do not overfill the appliance to avoid obstructing the air flow.
- ▶ Avoid air within the food packaging.
- ▶ Keep door seals clean so that the door always closes correctly.
- ▶ Defroze frozen food in the fridge storage compartment
- ▶ The most energy-saving configuration requires drawer, food box and shelves to be positioned in the appliance in a factory-fresh condition, and food to be placed without blocking the air outlet of the duct.



WARNING!

Disconnect the appliance from the power supply before cleaning.

Cleaning

Clean the appliance when only little or no food is stored.

The appliance should be cleaned every four weeks for good maintenance and to prevent bad stored food odors.



WARNING!

- ▶ Do not clean the appliance with hard brushes, wire brushes, detergent powder, petrol, amyl acetate, acetone and similar organic solutions, acid or alkaline solutions. Please clean with special refrigerator detergent to avoid damage.
- ▶ Do not spray or flush the appliance during cleaning.
- ▶ Do not use water spray or steam to clean the appliance.
- ▶ Do not clean the cold glass shelves with hot water. Sudden temperature change may cause the glass to break.
- ▶ Do not touch the inside surface of the freezer storage compartment, especially with wet hands, as your hands may freeze onto the surface.
- ▶ In case of heating check the condition of frozen goods.

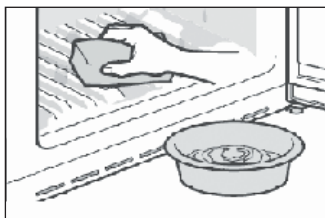

- ▶ Always keep the door gasket clean.
- ▶ Clean the inside and housing of the appliance with a sponge dampened in warm water and neutral detergent.
- ▶ 1. Please scrub the interior and exterior of the refrigerator, including door sealing, door rack, glass shelves, boxes and so on, with a soft towel or sponge dipped in warm water (you may add neutral detergent into the warm water).
- ▶ 2. If there is liquid spilled, remove all the contaminated parts, directly rinse with the flow water, dry and place it back into the fridge.
- ▶ 3. If there is spilled cream (such as the cream, melting ice cream), please remove all the contaminated parts, put into the warm water with about 40 °C for some time, then rinse with the flow water, dry and place it back into the fridge.
- ▶ 4. In case some small part or component gets stuck inside of the fridge (between shelves or drawers), use small soft brush to release it. If you could not reach the part, please contact Haier service
- ▶ Rinse and dry with soft cloth.
- ▶ Do not clean any of the parts of the appliance in a dishwasher.
- ▶ Allow at least 5 minutes before restarting the appliance as frequent starting may damage the compressor.

Defrosting

The defrosting of the refrigerator and the freezer compartment are done automatically; no manual operation is needed.

Replacing the LED-lamps

**WARNING!**

Do not replace the LED lamp yourself, it must only be replaced by either the manufacturer or the authorised service agent.

The lamps adopts LED as its light source, featuring low energy consumption and long service life. If there is any abnormality, please contact the customer service . See CUSTOMER SERVICE.

Parameters of the lamps:

Model	Fridge compartment	
	Voltage	Max Power
HRF510BW	12V	2W
HRF510BS		
HRF510FS		
HRF510BHC		
HRF510FHS		7W
HRF510FHC		

Non-use for a longer period

if the appliance is not used for an extended period of time, and you will not use the Holiday-function for the refrigerator:

Take out the food.

Unplug the power cord.

Clean the appliance as described above.

Keep the doors open to prevent the creation of bad odours inside.

**NOTICE**

Turn the appliance off only if strictly necessary.

Moving the appliance

1. Remove all food and unplug the appliance.
2. Secure shelves and other moveable parts in the fridge and the freezer with adhesive tape.
3. Do not tilt the refrigerator more than 45° to avoid damaging the refrigeration system.



WARNING!

- ▶ Do not lift the appliance by its handles.
- ▶ Never place the appliance horizontally on the ground.

Many occurring problems could be solved by yourself without specific expertise. In case of a problem please check all shown possibilities and follow below instructions before you contact an after sales service. See CUSTOMER SERVICE.



WARNING!

- ▶ Before maintenance, deactivate the appliance and disconnect the mains plug from the mains socket.
- ▶ Electrical equipment should be serviced only by qualified electrical experts, because improper repairs can cause considerable consequential damages.
- ▶ A damaged supply should only be replaced by the manufacturer, its service agent or similarly qualified persons in order to avoid a hazard.

Troubleshooting table

Problem	Possible Cause	Possible Solution
The compressor does not work.	Mains plug is not connected in the main socket.	Connect the main plug.
	The appliance is in the defrosting cycle.	This is normal for an automatic defrosting.
The appliance runs frequently or runs for a too long period of time.	The indoor or outdoor temperature is too high.	In this case, it is normal for the appliance to run longer.
	The appliance has been off power for a period of time.	Normally, it takes 8 to 12 hours for the appliance to cool down completely.
	A door/drawer of the appliance is not tightly closed.	Close the door/drawer and ensure the appliance is located on a levelled ground and there is no food or container holding the door.
	The door/drawer has been opened too frequently or for too long.	Do not open the door/drawer too frequently.
	The temperature setting for the freezer compartment is too low.	Set the temperature higher until a satisfactory fridge temperature is obtained. It takes 24 hours for the fridge temperature to become stable.
	The door/drawer gasket is dirty, worn, cracked or mismatched.	Clean the door/drawer gasket or replace them through the customer service.
	The required air circulation is not guaranteed.	Ensure adequate ventilation.

Troubleshooting

Problem	Possible Cause	Possible Solution
The inside of the refrigerator is dirty and/or with smell.	The inside of the refrigerator needs cleaning.	Clean the inside of the refrigerator.
	Food with strong odour is stored in the refrigerator.	Wrap the food thoroughly.
It is not cold enough inside the appliance.	The temperature is set too high.	Reset the temperature
	Too warm food have been stored.	Always cool down food before storing them.
	Too much food has been stored at one time.	Always store small quantities of food.
	The foods are too close to each other.	Leave a gap between several foods allowing air flowing.
	A door/drawer of the appliance is not tightly closed.	Close the door/drawer.
	The door/drawer has been opened too frequently or for too long.	Do not open the door/drawer too frequently.
It is too cold inside the appliance.	The temperature is set too low.	Reset the temperature.
	The Super Freeze function is activated or is running too long.	Switch off the Super Freeze function.
Moisture forming on the inside of the refrigerator compartment.	The climate is too warm and too damp.	Increase the temperature.
	A door/drawer of the appliance is not tightly closed.	Close the door/drawer.
	The door/drawer has been opened too frequently or for too long.	Do not open the door/drawer too frequently.
	Food containers or liquids are left open.	Let hot foods cool to room temperature and cover foods and liquids.
Moisture accumulates on the refrigerators outside surface or between the doors/door and drawer.	The climate is too warm and too damp.	This is normal in damp climate and will change when the humidity decreases.
	The door/drawer is not closed tightly.	Ensure that he door/drawer is tightly shut.
The icons on display flash in turn and cooling system does not work.	It is in demo mode	Refrigerator is plug in power Press and hold the "ZONE" button, and click the "Eco Mode" button five times, then the icons will stop flashing in turn.

Problem	Possible Cause	Possible Solution
Strong ice and frost in the freezer compartment.	The foods were not adequately packaged.	Always pack the foods well.
	A door/drawer of the appliance is not tightly closed.	Close the door/drawer.
	The door/drawer has been opened too frequently or for too long.	Do not open the door/drawer too frequently.
	The door/drawer gasket is dirty, worn, cracked or mismatched.	Clean the door/drawer gasket or replace them by new ones.
	Something on the inside prevents the door/drawer to close properly.	Reposition the shelves, door racks, or internal containers to allow the door/drawer to close.
The appliance makes abnormal sounds.	The appliance is not located on levelled ground.	Adjust the feet to level the appliance.
	The appliance touches some object around it.	Remove objects around the appliance.
A slight sound is to be heard similar to that of flowing water.	This is normal.	/
You will hear an alarm beep.	The fridge storage compartment door is open.	Close the door or silence the alarm manually.
You will hear a faint hum.	The anti-condensation system is working.	This prevents condensation and is normal.
The interior lighting or cooling system does not work.	Main plug is not connected in the main socket	Connect the main plug.
	The power supply is not intact.	Check the electrical supply to the room. Call the local electricity company!
	The LED-lamp is out of order.	Please call the service for changing the lamp.
The sides of the cabinet and door strip get warm.	This is normal.	/
No water is coming out of the water dispenser spout	Lock is not deactivated.	Deactivate the lock

Power interruption

- ▶ In the event of a power cut, food should remain safely cold for about 13 hours. Follow these tips during a prolonged power interruption, especially in summer.
- ▶ Open the door/drawer as few times as possible.
- ▶ Do not put additional food into the appliance during a power interruption.
- ▶ If prior notice of a power interruption is given and the interruption duration is longer than 13 hours, make some ice cubes and put them in a container on the top shelf of the refrigerator compartment.
- ▶ An inspection of the foods is required immediately after the interruption.
- ▶ As temperature in the refrigerator will rise during a power interruption or other failure, the storage period and edible quality of food will be reduced. Any food that defrosts should be either consumed, or cooked and refrozen (where suitable) soon afterwards in order to prevent health risks.



NOTICE

Memory function during power interruption

After the recovery of power, the appliance continues with the settings that were set before the power failure.

To contact the technical assistance, visit our website: <https://corporate.haier-europe.com/en/>

Under the section "website", choose the brand of your product and your country. You will be redirected to the specific website where you can find the telephone number and other ways to contact the technical assistance.

Unpacking



WARNING!

- ▶ The appliance is heavy. Always handle with at least two persons.
- ▶ Keep all packaging materials out of children's reach and dispose them in an environmentally friendly manner.
- ▶ Take the appliance out of the packaging.
- ▶ Remove all packaging materials.

Environmental conditions

The room temperature should always be between 10° C and 43° C, since it can influence the temperature inside the appliance and its energy consumption. Do not install the appliance near other heat-emitting appliances (ovens, refrigerators) without isolation.

Ventilation cross-section

To achieve sufficient ventilation of the appliance for safety reasons, the information of the required ventilation cross sections must be observed.

Space requirement

Required space when door is opened.

Model	Appliance width in mm		Appliance Depth in mm	
	W1	W2	D1	D2
HRF510BW	1249	-	626	1439
HRF510BS				
HRF510BHC				

Model	Appliance width in mm		Appliance Depth in mm	
	W1	W2	D1	D2
HRF510FS	1020	1250	626	1039
HRF510FHS				
HRF510FHC				

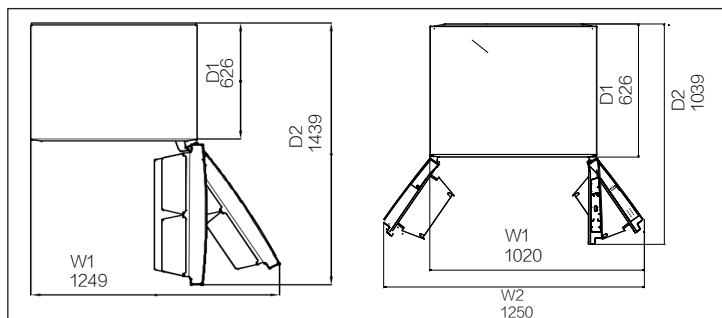

Environmental conditions

This appliance should be installed in a room that is dry and well ventilated. To provide adequate ventilation, make sure the refrigerator is at least 30mm clear on all sides from kitchen cabinetry (If HRF510B*, HRF510BH*, at least 50mm), and 50mm from the back wall. Any units placed above the appliance must be clear by 50mm to allow sufficient ventilation.

If locating the refrigerator close to a corner, sufficient spacing must be left for opening the doors and removing the shelves.

This appliance should be at least 100mm from any electric or gas cooker. If this is not possible, make sure that appropriate insulation is used (eg insulated wall).

Avoid exposing the appliance to direct sunlight, and sources of heat (such as radiators, heaters or cookers).

Locating this appliance in a cold environment (such as a shed, outhouse or garage) may compromise its performance. A consistent room temperature of 10°C or above is recommended to ensure optimum performance and food care.

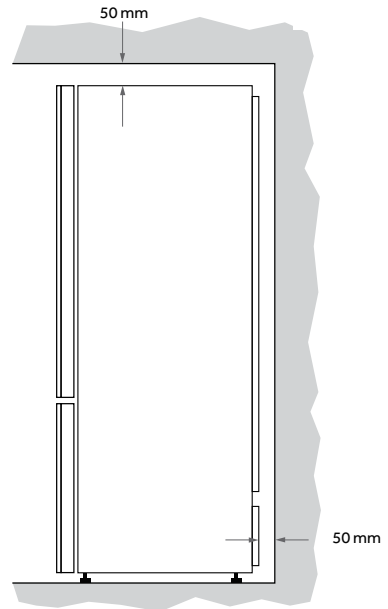

Installation distance

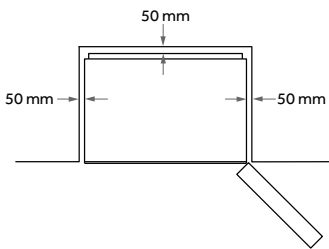

Door rotation Installation distance
(HRF510B*, HRF510BH*)

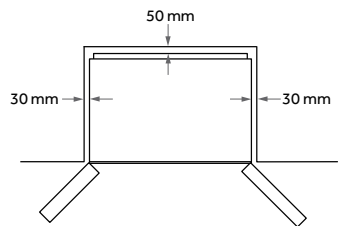

Door rotation Installation distance
(HRF510F*, HRF510FH*)

Aligning the appliance

The appliance should be placed on a flat and solid surface.

1. Tilt the refrigerator slightly backwards.
2. Set the feet to the desired level.

Make sure the distance to the wall on the hinge side is at least 100 mm for the door to open properly.

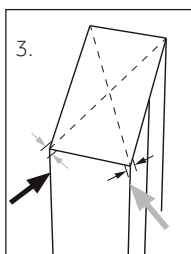
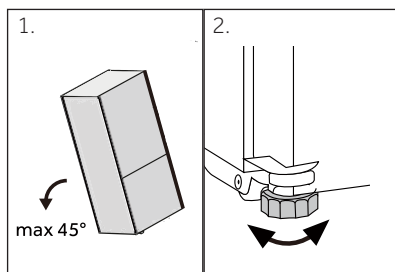

1. The stability can be checked by alternately bumping on the diagonals. The slightly swaying should be the same in both directions. Otherwise the frame can warp; possible leaking door seals are the result. A low tendency to the rear facilitates the closing of the doors.

i NOTICE

For a free standing appliance: this refrigerating appliance is not intended to be used as a built-in appliance

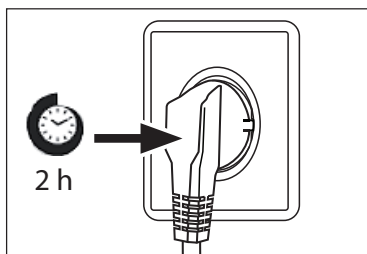

Waiting time

To the maintenance-free lubrication oil is located in the capsule of the compressor. This oil can get through the closed pipe system during slanting transport. Before connecting the appliance to the power supply you have to wait at least 2 hours so that the oil runs back into the capsule.

Electrical connection

Before each connection check if:

- ▶ power supply, socket and fusing are appropriate to the rating plate.
- ▶ the power socket is earthed and no multi-plug or extension.
- ▶ the power plug and socket are strictly according.

Connect the plug to a properly installed household socket.

! WARNING!

To avoid risks a damaged power cord must be replaced by the customer service (see warranty card).

Door Reversibility

Before connecting the appliance to the power supply, you should check whether the door swing must be changed from right (as delivered) to left, if this is required by the installation location and the usability.



WARNING!

- ▶ The appliance is heavy. You need two persons to carry out the door reversibility.
- ▶ Before any operation, first unplug the appliance from the mains
- ▶ Do not tilt the appliance more than 45°C to prevent damage of the refrigeration system.

Assembly steps

1. Provide necessary tool.
2. Unplug the appliance from the main supply firstly.
3. Remove the fixation of the cover.
4. Remove the screw at the hinge
5. Remove the hinge cover.
6. Unscrew the upper hinge
7. Lift the loose upper door carefully off the lower hinge.
8. Change the trim cover from the current position to opposite side.
9. Change the door stop from the current position to opposite side.
10. Remove the screws that secure the left hinge box
11. Remove the decorative component at the front end of the left hinge; Remove the hook at the front end of the right hinge cover; Install the left hinge cover decoration onto the right hinge cover; Install the hook in the gift bag onto the left hinge cover.
12. Fix the assembled right hinge cover onto the refrigerator with screws.
13. Unscrew the middle hinge of the upper door
14. Change the positions of the blanking plugs and the screw on the side

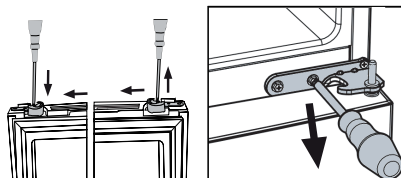
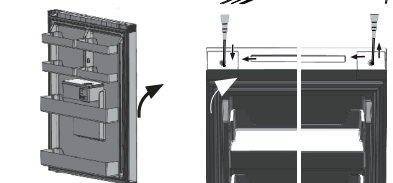
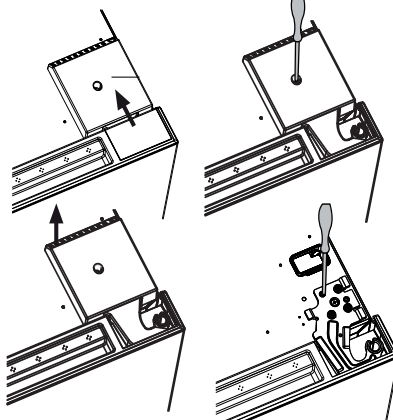
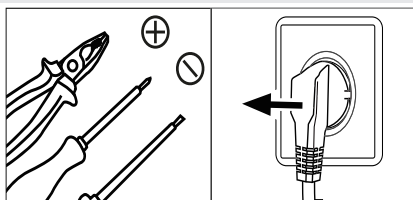

15. Rotate the middle hinge 180 ° and install it on the left end of the middle beam .

16. Remove the hinges and corners at the bottom of the refrigerator, and install the corners on the right side of the bottom of the refrigerator.

17. Install the following diagram, remove and reassemble the lower hinge.

18. Change the positions of the blanking plug at the top of the lower door.

19. Refer to the method of replacing the stopper of the refrigeration door body, and swap the stopper at the bottom of the refrigeration door body left and right.

20. Install the freezer door onto the refrigerator.

21. Install the reassembled lower hinge onto the bottom of the left side of the refrigerator; First fix the screw at the position of the circular hole (red arrow); Then fix the front two screws (green arrows)

22. Adjust the freezing door body to ensure good sealing.

23. Install the refrigeration door onto the middle hinge.

Install the upper left hinge in the gift bag onto the refrigerator and secure it with screws

After the change of the door, check if the door seals are located properly on the housing and all screws are tightened well.

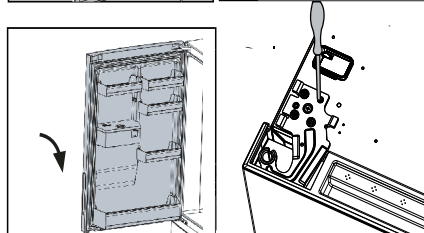
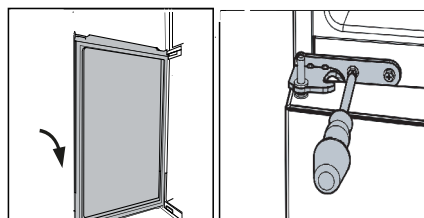
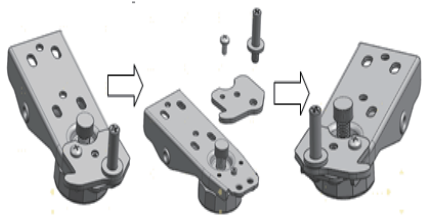
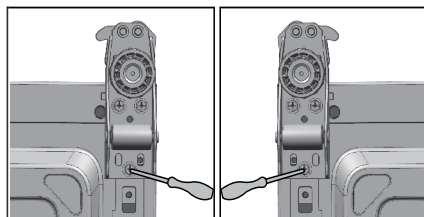
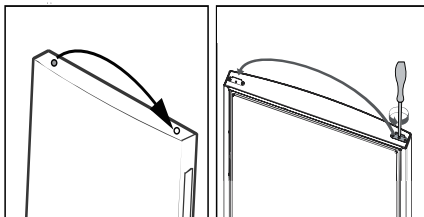
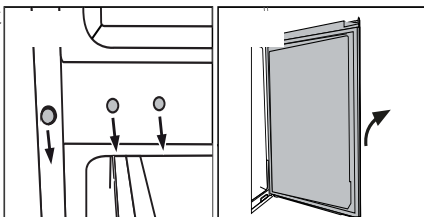

Product parameters according to regulation

Based on standard test results for 24 hours. Actual energy consumption will depend on how the appliance is used and where it is located

Trademark	Haier	
Model No.	HRF510B*	HRF510BH*
Category of the model	Refrigerator-freezer	
Voltage/frequency	220V-240V~/50Hz	
Energy Star	5.5 Star	
Frost-free system	Yes	
Product group	5B	
Total storage volume(L)	517	514
Fresh food compartment Volume(L)	379	376
Freezer compartment Volume(L)	138	138
Climate class	T	
Refrigerant	R600a 70g	
Insulation blowing gas	HC-C601	
Dimension (DxWxH)	707x790x1725mm	
Protection class	I	

Trademark	Haier	
Model No.	HRF510F*	HRF510FH*
Category of the model	Refrigerator-freezer	
Voltage/frequency	220V-240V~/50Hz	
Energy Star	5star	
Frost-free system	Yes	
Product group	5B	
Total storage volume(L)	512	509
Fresh food compartment Volume(L)	375	372
Freezer compartment Volume(L)	137	137
Climate class	T	
Refrigerant	R600a 70g	
Insulation blowing gas	HC-C601	
Dimension (DxWxH)	707x790x1725mm	
Protection class	I	

Q.C.PASSED

**CERTIFICATE
OF QUALITY**

**DESIGNATION:
REFRIGERATOR**

CHECKER No:

Haier

2025 Version A



0000000000