



User manual
Washing machine

HWF75KW1
HWF85KW1
HWF85KB1

NZ AU

Haier

Thank you for purchasing a Haier Product.

Please read these instructions carefully before using this appliance. The instructions contain important information which will help you get the best out of the appliance and ensure safe and proper installation, use and maintenance.

Keep this manual in a convenient place so you can always refer to it for the safe and proper use of the appliance.

If you sell the appliance, give it away, or leave it behind when you move house, make sure you also pass this manual so that the new owner can get familiar with the appliance and safety warnings.



Legend

Warning-Important Safety information



General information and tips



Environmental information



Disposal

Help protect the environment and human health. Put the packaging in applicable containers to recycle it. Help to recycle waste of electrical and electronic appliances. Do not dispose appliances marked with this symbol with the household waste. Return the product to your local recycling facility or contact your municipal office.



WARNING!

Risk of injury or suffocation!

Disconnect the appliance from the mains supply. Cut off the mains cable and dispose of it. Remove the door catch to prevent children and pets from getting trapped in the appliance.

1-Safety information.....	4
2-Product description.....	7
3-Control panel.....	8
4-Cycles.....	12
5-Consumption.....	14
6-Daily use.....	15
7-Eco-friendly washing.....	20
8-Care and cleaning.....	21
9-Troubleshooting.....	23
10-Installation.....	27
11-Technical data.....	31
12-Customer service.....	33

Before switching on the appliance for the first time, read the following safety hints!



WARNING!

Before first use

- ▶ Do not operate this machine if it has been damaged during transportation. Contact your dealer or Haier service technician.
- ▶ Ensure all transport bolts are removed before running the appliance. Failure to do so might end in damage to the appliance.
- ▶ Remove all packaging and keep out of reach of children.
- ▶ This appliance is heavy, we recommend 2 people to move and install the appliance.
- ▶ This product has been designed for personal, family or household use.
This product is not designed for any commercial use. Any commercial use will terminate this product's manufacturer's warranty.

Daily use

- ▶ This appliance is not intended for use by persons (including children) with reduced physical, sensory or mental capabilities, or lack of experience and knowledge, unless they are supervised or given instructions on how to use it by someone responsible for their safety.
- ▶ Supervise children to ensure they do not play with the appliance or climb inside the drum.
- ▶ Do not swing on or put weight on the door.
- ▶ The appliance should only be used for garments recommended for machine washing. Always follow the advice on the care label.
- ▶ Do not touch or operate the machine with wet hands or with bare feet.
- ▶ Do not place dripping wet clothing in or on top of the appliance as it may create an electrical hazard.
- ▶ Do not use the appliance if industrial chemicals (e.g. solvents) have been used on the clothes.
- ▶ Remove all items such as lighters and matches from pockets.
- ▶ Pull up zips, fix loose threads and protect embellishments to prevent garments from being damaged and entangled.
- ▶ Garments that contain metal reinforcements should not be placed in the appliance. If necessary, use an appropriate laundry bag or net.



WARNING!

Daily use

- ▶ The appliance might get hot during operation, use caution if in close proximity.
- ▶ Unplug the appliance before undertaking maintenance. Hold the plug (not the cable) when unplugging the machine.
- ▶ Ensure there are no undesirable objects inside the drum before starting a cycle.
- ▶ Ensure that the ambient temperature is between 5°C and 35°C before using the appliance.

Capacity

- ▶ Do not load the appliance beyond its rated capacity
- ▶ **MAXIMUM WASH CAPACITY:** HWF75K: 7.5Kg, HWF85K: 8.5Kg
- ▶ Capacity refers to the maximum dry weight of items the appliance can wash each time

Washer Information

- ▶ Do not open the detergent dispenser drawer during a cycle.
- ▶ If a high wash temperature is selected, the door glass will become hot. Do not touch the surface and keep children away from the appliance.
- ▶ Do not add petrol, dry-cleaning solvents, perfumes or other flammable or explosive substances to the wash water. These substances give off vapours that could ignite or explode.
- ▶ Do not wash articles that have been previously cleaned in, washed in, soaked in, or spotted with gasoline, dry-cleaning solvents, or other flammable or explosive substances as they give off vapours that could ignite or explode.
- ▶ Do not wash an electric blanket in your washer unless the care label specifically states it is safe to do so.
- ▶ Fabric softeners, or similar products, should be used as specified by the manufacturer instructions.

**WARNING!**

Maintenance, Cleaning and Disposal

- ▶ Keep the gasket, dispenser and door clean to prevent odours.
- ▶ Do not use water spray or steam to clean the appliance.
- ▶ A damaged electrical cable must be replaced by a Haier service technician or similarly qualified person. Do not use the appliance until it has been repaired to avoid a risk of electric shock.
- ▶ When disposing of the appliance, it is recommended that the door is removed to avoid children getting trapped inside, and that the electrical cable is cut off close to the machine.
- ▶ Unless the product is modified by an certified technician, any changes might result in loss of warranty.

Intended use

This appliance is intended for washing machine-washable laundry only. Please follow the instructions on the label of each garment. It is designed exclusively for domestic use inside the house. It is not intended for commercial or industrial use.

Changes or modifications to the device are not allowed. Unintended use may cause hazards and loss of all warranty and liability claims.

i Note:

Due to technical changes and different models, the illustrations in the following chapters may differ from your model.

2.1 Picture of appliance

Front (Fig. 2-1):



Rear side (Fig. 2-2):

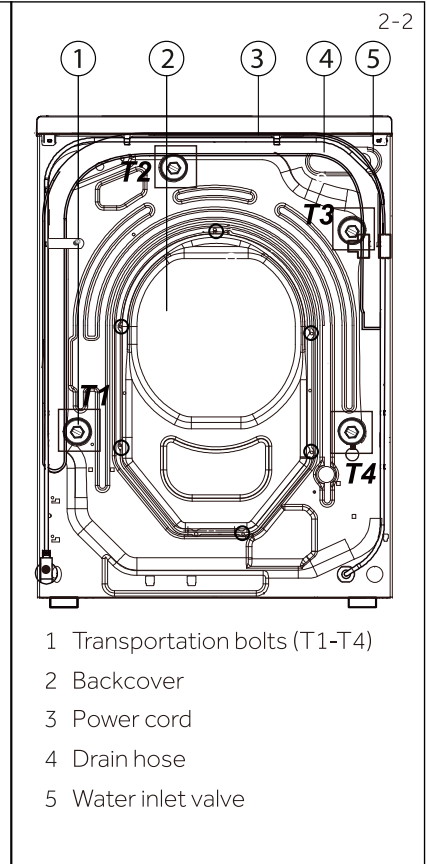

2.2 Accessories

Check the accessories and literature in accordance with this list (Fig. 2-3):

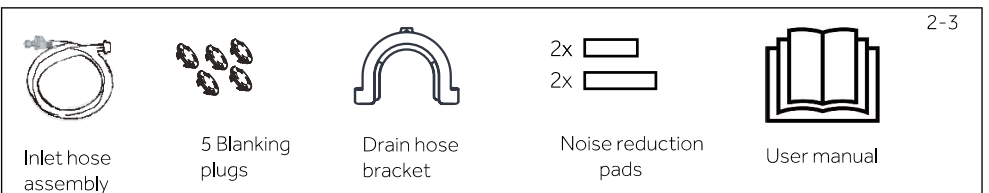

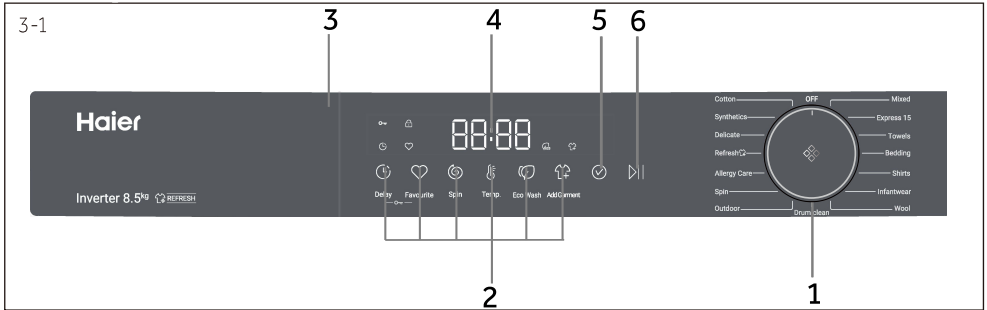

- 1 Dial
- 2 Function buttons
- 3 Dispenser
- 4 Display
- 5 "Confirm" button
- 6 "Start/Pause" button

3.1 Dial

By turning the dial (Fig. 3-2) one program at a time can be selected. The default settings of the program will be displayed.

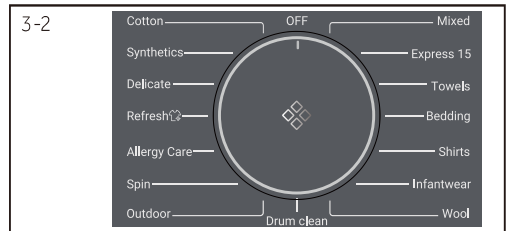

3.2 Display

The display (Fig. 3-3) will show important information about the cycle: Options and modifiers, remaining time, error codes and service information, warnings and notifications.



Symbol	Meaning
	Control panel is locked.
	Drum door is locked.
	Delay Start
	Favourite.
	Eco mode
	Add garment.

3.3 Function buttons

After selecting a cycle, users can also select different functions based on their needs by pressing the function buttons (Fig. 3-4).

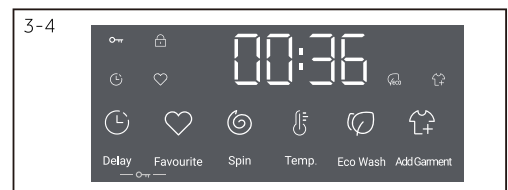

i **Note: Default settings**

To get best results in each cycle, Haier has defined specific default settings. If there is no special requirement, default settings are recommended.



3.3.1 Delay

The button is used to adjust the scheduled time continuously. The adjustable time ranges from 15 minutes, 30 minutes, 1 hour, 2 hours, up to 12 hours. After 1 hour, each press increases the scheduled time by 1 hour.

i **Note**

This function should be set after you have completed selecting the required options.



3.3.2 Favourite

Select the desired cycle on the dial, then select the modifiers that you want to save for that cycle. Press the "Favourite" button (Fig. 3-6) – the LED flashes 2s and the machine beeps. Then the "♥" LED stays illuminated indicating that the favourites configuration has been saved.

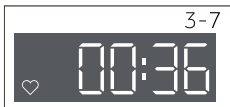

The next time you select this cycle, the icon ♥ will light up (Fig. 3-7), it will automatically come with your preferred settings.

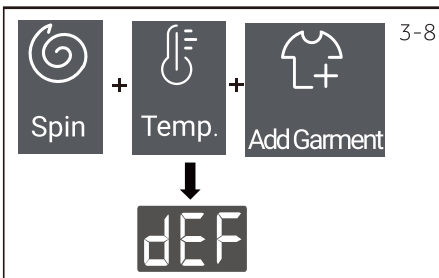

Quick method to deactivate preferred settings for all cycles, just select the "Express 15" cycle, then press the "Spin," "Temp." and "Add Garment" buttons (Fig. 3-8) simultaneously for 3 seconds, the screen will display **dEF**, and all cycles will go back to the default settings.

3.3.3 Spin

Press this button (Fig. 3-9) to select the spin speed (0, 400, 600, 800, 1000, 1200, 1400 (HWF85K only)). If the value "0" is displayed, the laundry will not spin.

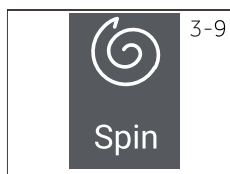

3.3.4 Temp.

Press this button (Fig. 3-10) to select the washing temperature. If the screen displays "--□", it means the water will not be heated.

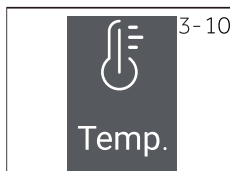

3.3.5 Eco Wash

Use the button (Fig.3-11)to turn the ECO function ON & OFF during wash.

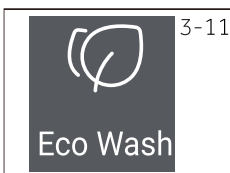

3.3.6 Add Garment

During the cycle, touch the "Add Garment" buttons (Fig. 3-12) to activate the Add Garment function.

Cycle will be paused (if the water level is too high, product will drain the water to a level where the door can be opened), then users can open the door, put the garments into the drum and close the door, then press the "Confirm" button and "Start/Pause" button to resume the cycle.

"Add Garment" is only available during sensing, filling or washing stages AND if the temperature selected is Cold/30/40. If "Add Garment" is pressed at any other stage of the cycle, the machine will beep but it will not pause or drain.

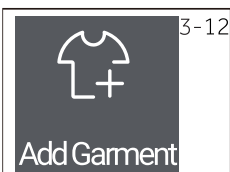

3.3.7 Confirm

In order to start the cycle, press the 'Confirm' button (Fig. 3-13) first, to lock in the cycle selections.

Then press the Start/Pause button (Fig. 3-14) to start the cycle.



3.3.8 Start/Pause

Press the Start/Pause button (Fig. 3-14) to start a washing cycle.

Press the button again to pause the washing cycle.



Press the button again to continue the cycle.

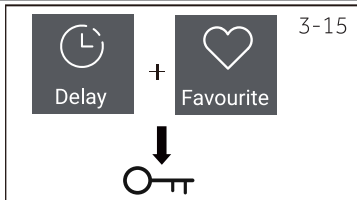



3-15

3.3.9 Key lock

Press the "Delay" and "Favourite" buttons (Fig. 3-15) simultaneously for 3 seconds to activate the Key Lock function. The screen will display the icon . Once activated, if a button is pressed, the screen will display  (Fig. 3-16). Use the same method to deactivate the Key Lock function. The Key Lock function can be selected at any time.



3-16



Note: Key lock

- ▶ The Key Lock function can be activated and deactivated manually at any time.
- ▶ Key Lock remains activated at the end of a cycle.
- ▶ Key Lock remains activated if the machine is powered off via the display or switched off at the wall.
- ▶ When powered back on, the product will still have Key Lock activated.
- ▶ The Key Lock function cannot be activated or deactivated through the App.

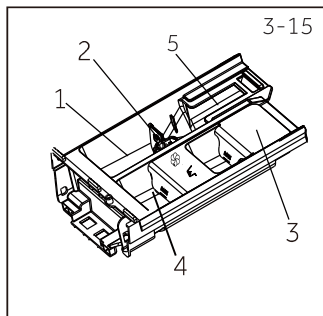

3-15

3.4 Dispenser

Within the dispenser drawer are the following compartments (Fig.3-15).

1. Compartment for powder or liquid detergent.
 2. Detergent flap selector, lift it up for powder detergent, keep it down for liquid detergent.
 3. This compartment is not available on HWF75K and HWF85K.
 4. Compartment for softner.
 5. Lock tab, press it down to pull out dispenser drawer.
- Please refer to the detergent manufacturer's information, when selecting suitable detergents

HWF75K

• Yes, ○ Optional, / No

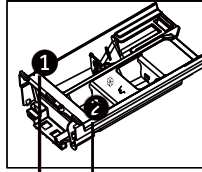

Detergent compartment for:

- ① Power Detergent/Liquid Detergent²⁾
- ② Softener or care product

Cycle	Max. load in kg	Temperature			Fabrics type	Default spin speed in rpm	Function				default duration(min)
		in ¹⁾ selectable range	Default	Detergent			Softener or care product				
Mixed	7.5	-- to 60	30	○	/	1000	○	○	○	○	AUTO
Express 15	1	-- to 40	--	○	Cotton / Synthetic	1000	○	○	/	○	15
Towels	7.5	-- to 80	60	○	Cotton / Synthetic	1200	○	○	○	○	AUTO
Bedding	5	-- to 60	30	○	Cotton	1000	○	○	○	○	89
Shirts	2.5	-- to 40	40	○	Cotton/Synthetic	1000	○	○	○	○	70
Infantwear	4	-- to 80	40	○	Cotton/Synthetic	1000	○	○	○	○	87
Wool	2.5	-- to 40	--	○	Machine-washable fabric made of wool or with wool content	800	○	○	/	○	40
Cotton	7.5	-- to 80	30	○	Cotton	1200	○	○	○	○	AUTO
Synthetics	4.5	-- to 60	30	○	Synthetic or mixed fabric	1000	○	○	○	○	AUTO
Delicate	2.5	-- to 30	30	○	Delicate laundry and silk	600	○	○	/	○	45
Refresh	1	--	--	/	Cotton/Synthetic	/	/	○	/	/	18
AllergyCare	7.5	-- to 80	60	○	Cotton/Synthetic	1000	○	○	○	○	102
Spin	/	--	--	/	Cotton/Synthetic Not-fragile fabric	1000	/	○	/	○	8
Outdoor	4	-- to 40	30	○	Cotton/Synthetic	1000	○	○	○	○	57
Drum Clean	/	-- or 80	80	/	/	/	/	○	/	○	60

-- Water will not be heated

- 1) Choose 90°C wash temperature only for special hygienic requirements.
- 2) Reduce detergent amount because the cycle "Express 15" duration is short.

HWF85K

• Yes, ◦ Optional, / No

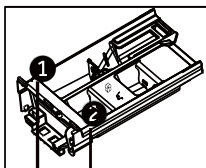

Detergent compartment for:

- ① Power Detergent/Liquid Detergent²⁾
- ② Softener or care product

Cycle	Max. load in kg	Temperature		Detergent	Softener or care product	Fabrics type	Default spin speed in rpm	Function				default duration(min)
		in ¹⁾ selectable range	Default					⌚	♥	YECO	LF	
Mixed	8.5	-- to 60	30	◦	◦	/	1000	◦	◦	◦	◦	AUTO
Express 15	1	-- to 40	--	◦	◦	Cotton / Synthetic	1000	◦	◦	/	◦	15
Towels	8.5	-- to 90	60	◦	◦	Cotton / Synthetic	1400	◦	◦	◦	◦	AUTO
Bedding	6	-- to 60	30	◦	◦	Cotton	1000	◦	◦	◦	◦	89
Shirts	2.5	-- to 40	40	◦	◦	Cotton/Synthetic	1000	◦	◦	◦	◦	70
Infantwear	4.5	-- to 90	40	◦	◦	Cotton/Synthetic	1000	◦	◦	◦	◦	87
Wool	2.5	-- to 40	--	◦	◦	Machine-washable fabric made of wool or with wool content	800	◦	◦	/	◦	40
Cotton	8.5	-- to 90	30	◦	◦	Cotton	1200	◦	◦	◦	◦	AUTO
Synthetics	5	-- to 60	30	◦	◦	Synthetic or mixed fabrics	1000	◦	◦	◦	◦	AUTO
Delicate	2.5	-- to 30	30	◦	◦	Delicate laundry and silk	600	◦	◦	/	◦	45
Refresh	1	--	--	/	/	Cotton/Synthetic	/	/	◦	/	/	18
AllergyCare	8.5	-- to 90	60	◦	◦	Cotton/Synthetic	1000	◦	◦	◦	◦	102
Spin	/	--	--	/	/	Cotton/Synthetic Not-fragile fabric	1000	/	◦	/	◦	8
Outdoor	4.5	-- to 40	30	◦	◦	Cotton/Synthetic	1000	◦	◦	◦	◦	57
Drum Clean	/	-- or 90	90	/	/	/	/	/	◦	/	◦	60

-- Water will not be heated

1) Choose 90°C wash temperature only for special hygienic requirements.

2) Reduce detergent amount because the cycle "Express 15" duration is short.

Registration Cycle

HWF75K

Registration cycle of HWF75KW1 for the Energy and Water Labeling is based on: AS/NZS 2040.2 Cotton, Temp.: 40°C, Spin: 1200, which is the recommended water and energy saving cycle for a normally soiled load in everyday washing scenarios.

HWF85K

Registration cycle of HWF85K Series for the Energy and Water Labeling is based on: AS/NZS 2040.2 Cotton, Temp.: 40°C, Spin: 1400, which is the recommended water and energy saving cycle for a normally soiled load in everyday washing scenarios.

The dry powder detergent was dosed at 100% of the standard quantity and placed directly at the bottom of the drum. Then, less than the maximum amount of anti-foaming agent was added to the bottom of the drum, followed by the PBIS solution. The standard load was then placed, and the performance program was started.



Note: Auto Weight

This product is equipped with a loading weight recognition sensor. When the load weight is low, corresponding energy, water and washing time will be adjusted automatically for some cycles. The displayed cycle duration may vary depending on the load weight, including "Mixed, Towels, Cotton, Synthetics" cycles.

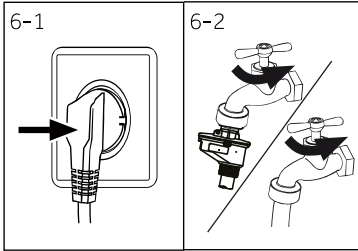

6.1 Power supply

Connect the product to a power socket (Fig. 6-1). Please also refer to section 11- Installation (see page 34).

6.2 Water connection

- ▶ Before connecting, make sure the water inlet is clean and intact.
- ▶ Connect the inlet hose to the wall tap and the water valve at the rear of the washing machine. Turn on the tap (Fig. 6-2)



Note: Tightness

Before use, turn on the tap to check if there is any water leakage around the joint between the tap and the inlet hose.

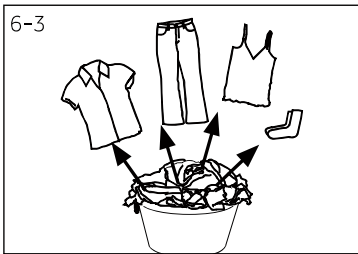

6.3 Preparing laundry

- ▶ Sort clothes according to fabric type (cotton, synthetic, wool or silk etc.) and how dirty they are (Fig.6-3). Follow instructions on the clothes labels.
- ▶ Separate white clothes from coloured ones. Wash coloured textiles first by hand to check if they fade or run.
- ▶ Empty pockets (keys, coins, etc.) and remove hard decorative objects (e.g. brooches).
- ▶ Garments without hems, delicates and finely woven textile such as fine curtains should be put into a wash bag to care for this delicate laundry (hand or dry cleaning would be better).
- ▶ Close zips, velcro fastener and hooks, make sure the buttons are sewn on tightly.
- ▶ Place sensitive items like laundry without firm hem, delicate underwear and small items such as socks, belts, bras, etc. in a wash bag.
- ▶ Unfold large pieces of fabric such as bed sheets, bedspreads etc.
- ▶ Turn jeans and printed, decorated or color-intensive textile inside out; possibly wash separately.



CAUTION!

Non-textile, as well as small, loose or sharp-edged items may cause malfunctions and damage to clothes and appliance.

Fabric Care chart

Washing		
 Washable upto 95°C normal process	 Washable up to 60°C normal process	 Washable up to 60 gentle process
 Washable up to 40°C normal process	 Washable up to 40°C gentle process	 Washable up to 40 very gentle process
 Washable up to 30°C normal process	 Washable up to 30°C gentle process	 Washable up to 30 very gentle process
 Wash by hand max. 40°C	 Do not wash	
Bleaching		
 Any bleaching allowed	 Only oxygen/ non-chlorine	 Do not bleach
Drying		
 Tumble drying possible normal temperature	 Tumble drying possible lower temperature	 Do not tumble dry
 Line drying	 Flat drying	
Ironing		
 Iron at a maximum temperature up to 200 °C	 Iron at a moderate temperature up to 150°C	 Iron at a low temperature up to 110 °C; without steam (steam ironing may cause irreversible damage)
 Do not iron		
Professional Textile Care		
 Dry cleaning in tetra-chloroethene	 Dry cleaning in hydrocarbons	 Do not dry clean
 Professional wet clean	 Do not professional wet clean	

Some of these symbols may not be in the device menu.

6.4 Loading the appliance

- ▶ Place the laundry into the drum, item by item.
- ▶ Don't overload the washing machine drum. Please refer to the cycle tables on pages 12 and 13 for maximum load sizes suitable for a selected cycle.
- ▶ Close the door carefully. Make sure that no pieces of laundry are pinched.

6.5 Selecting detergent

- ▶ Washing efficiency and performance is determined by detergent quality.
- ▶ Use only washing machine approved detergent.
- ▶ If needed, use specific detergents, e.g for synthetic and woolen fabric.

Cycle	Kind of detergent				
	Universal	Colour	Delicate	Special	Softener
Mixed	√	√	-	-	√
Express 15	√	√	-	-	√
Towels	-	√	-	-	√
Bedding	√	√	-	-	√
Shirts	√	√	-	-	√
Infantwear	-	-	√	√	√
Wool	-	-	√	√	√
Cotton	√	√	-	-	√
Synthetic	√	√	-	-	√
Delicate	-	-	√	√	√
Refresh	o	o	o	o	o
Allergy Care	√	√	-	-	√
Spin	-	-	-	-	-
Outdoor	-	-	-	√	o
Drum Clean	-	-	-	√	-

o = no - = Not Recommended √ = Recommended

If using liquid detergent, it is not recommended to activate the time delay.

We recommend by using:

- ▶ Laundry powder: 20°C to 90°C* (best use: 40-60°C)
- ▶ Color detergent: 20°C to 60°C (best use: 30-60°C)
- ▶ Wool/delicate detergent: 20°C to 30°C (best use: 20-30°C)

*Choose the highest wash temperature only for special hygienic requireme

*If you choose the a water temperature of 60°C, we recommend using less detergent.

*If suds are a problem, we recommend using less detergent, or a low sudsing detergent.

6.6 Adding detergent

1. Slide out the detergent drawer.
2. Put the detergent and softener into corresponding compartments(Fig. 6-4).
3. Close the detergent drawer gently.

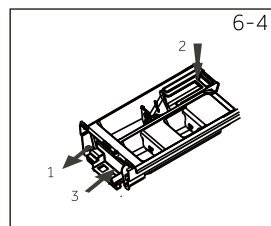

i Note:

- ▶ Please follow the instruction on the detergent package.
- ▶ Concentrated liquid detergent should be diluted before adding.
- ▶ Carefully choose the cycle settings according to the care symbols on all laundry labels and according to the cycle table.

6.7 Switch on the appliance

Switch on the washer by rotating the dial.(Fig.6-5)

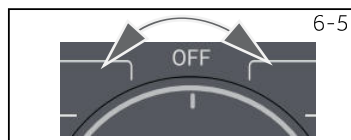

6.8 Select a cycle

To get the best washing results, select a cycle which best fits the degree of soiling and type of laundry. Turn the dial (Fig. 6-6) to select the desired cycle.

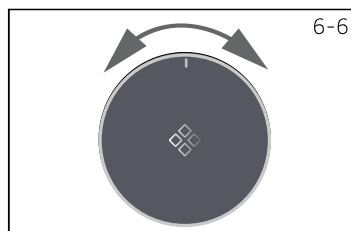

i Note: Odour removal

Before first use, we recommend to run cycle "Drum clean" with no load and small amount of detergent in the detergent compartment (2) or a special washing machine cleaning product to remove odours.

6.9 Add individual selections

Select required options and settings (Fig. 6-7); refer to Control Panel.



6.10 Start the cycle

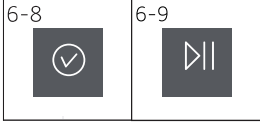

After selecting the cycle and preferred settings, press the "Confirm" button (Fig. 6-8), then press the "Start/Pause" button (Fig. 6-9), the product will start running.

6.11 Pause/change cycle

During the cycle, press the "Start/Pause" button to pause the cycle, then press it again to resume the cycle.

To change to another cycle when the product is running, press the "Start/Pause" button to pause the cycle, use the dial to select another cycle, press the "Confirm" and "Start/Pause" button in order, the product will start running.

6.12 After washing

Note: Door lock

- ▶ For safety reasons, the door is locked during the washing cycle. It is only possible to open the door at the end of the cycle or after the cycle was cancelled correctly (see description above).
- ▶ When the water level is high, the water temperature is high, or the drum is spinning, it is not possible to open the door. The door will remain locked for the duration of the cycle.

1. At the end of the cycle, the screen will display "End".
2. The appliance switches off automatically
3. Remove laundry as soon as possible to avoid the formation of wrinkles.
4. Turn off the water supply.
5. Unplug the power cord.
6. Open the door to prevent formation of moisture and odours. Leave it open while not in use.

Note: Standby-mode/energy-saving mode

To save energy, the product will enter standby-mode and the display will turn off after 2 minutes of inactivity. Turn the dial to exit the standby-mode.

6.13 Activate or deactivate the buzzer

The acoustic signal can be selected if necessary:

1. Switch on the appliance.
2. Touch the "Delay" button and "Spin" button at the same time for about 3 seconds. "OFF" will be displayed and the buzzer will be deactivated.

For activating the buzzer, touch these two buttons at the same time again. "ON" will be displayed.



Environmentally responsible use

- ▶ To achieve best use of energy, water, detergent and time, you should use the recommended maximum load size.
- ▶ Do not overload the washing machine (hand width clearance above laundry).
- ▶ For slightly soiled laundry, select the Express15 cycle.
- ▶ Apply exact dosages of each washing agent.
- ▶ Choose the lowest suitable washing temperature, modern detergents are effective below 60°C.
- ▶ Adjust default settings up only when there is heavy stains.

General information:

- ▶ The "Mixed" cycle is able to clean normally soiled cotton laundry declared to be washable at 40 °C or 60 °C;
- ▶ The most efficient cycles in terms of energy consumption are generally those that perform at lower temperatures and longer duration;
- ▶ Noise and remaining moisture content are influenced by the spinning speed: the higher the spinning speed in the spinning phase, the higher the noise and the lower the remaining moisture content.

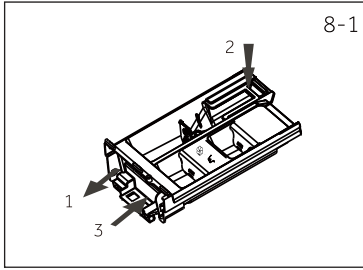

8-1

8.1 Cleaning the detergent drawer

Make sure there are no detergent residues. Clean the drawer regularly (Fig. 8-1):

1. Pull out the drawer until it stops.
2. Press the release button and remove the drawer.
3. Wipe the inside of each compartment with a towel.
4. Flush the drawer with water until it is clean and insert the drawer back in the appliance.



8-2

8.2 Cleaning the machine

- ▶ Unplug the machine during cleaning and maintenance.
- ▶ Use a soft cloth with soap liquid to clean the machine exterior surfaces (Fig 8-2) and rubber components.
- ▶ Do not use organic chemicals or corrosive solvents.

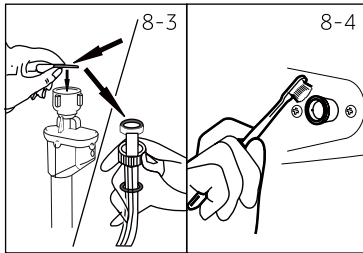

8-3

8-4

8.3 Water inlet valve and inlet valve filter

To prevent blockage of water supply by solid substances like lime, clean the inlet valve filter regularly.

- ▶ Unplug the power cord and turn off the water supply.
- ▶ Unscrew the water inlet hose at the back (Fig. 8-3) of the appliance as well as on the tap.
- ▶ Flush the filters with water and a brush (Fig. 8-4).
- ▶ Insert the filter and install the inlet hose.
- ▶ Turn on the tap to see if it leaks.

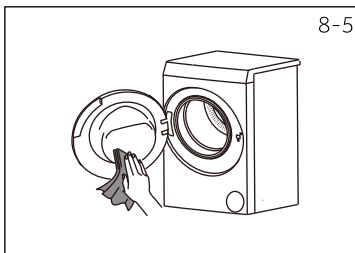

8-5

8.4 Cleaning the drum

- ▶ Remove accidentally washed items, especially metal parts such as pins, coins, etc. from the drum (Fig. 8-5) and the groove of the door gasket (rubber) because they cause rust stains and damage.
- ▶ Use a non-chloride cleaner for removing rust stains. Observe the warning hints of the cleaning agent manufacturer.
- ▶ Do not use any hard objects or steel wool for cleaning.

- ▶ After the procedure, open the door, use a towel to clean the stains and foam around the gasket, and keep the inside and outside of the gasket clean.



Note: Hygiene

For regular maintenance, we recommend running the cycle "Drum clean" within every 100 cycles to avoid residue and odour build up. Add a small amount of detergent to the detergent compartment (2) or use a special machine cleaner.

8.5 Long periods of disuse

If the appliance is left idle for a long period:

1. Pull out the electrical plug (Fig. 8-6).
2. Turn off water supply (Fig.8-7).
3. Open the door to prevent formation of moisture and odours. Leave it open while not used.

Before next usage, carefully check the power cord, water inlet and drain hose. Make sure everything is properly installed and without leakage.

8.6 Pump filter

Clean the filter once a month and check the pump filter for instance if the appliance:

- ▶ Doesn't drain the water.
- ▶ Doesn't spin.
- ▶ Cause unusual noise while running.



WARNING!

Scalding Risk! Water in the pump filter can be very hot! Before any operation, please ensure water has cooled down.

1. Turn off and unplug the machine (Fig. 8-8).
2. Push and open service flap (Fig.8-9).
3. Provide a flat container to catch residual water. (Fig 8-10) There could be bigger amounts!
4. Pull the drain hose out and hold its end above the container (Fig. 8-10).
5. Take the sealing plug out of the drain hose (Fig. 8-10).
6. After complete drainage, close drain hose (Fig. 8-11) and push it back into the machine.
7. Unscrew and remove the pump filter in counterclockwise direction(Fig.8-12).
8. Remove contaminants and dirt (Fig.8-13).
9. Carefully clean the pump filter.e.g. using running water(Fig.8-14).
10. After cleaning, reinstall the handle and tighten it until it does not move. At this time, the handle is in vertical state.(Fig.8-15)
11. Close service flap.

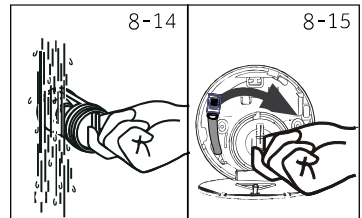
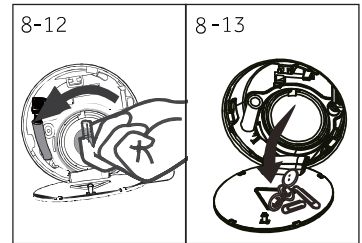
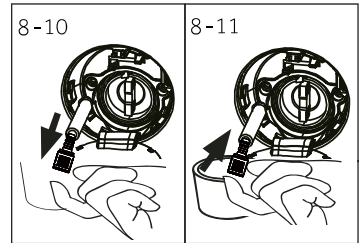
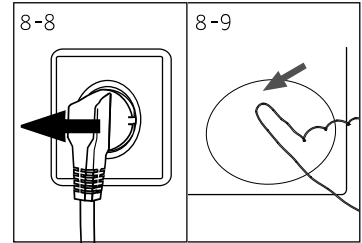
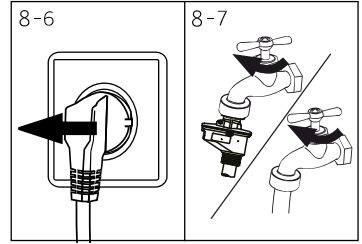

CAUTION!

- ▶ Pump filter sealing has to be clean and undamaged. If the lid is not fully tightened, water can escape.
- ▶ The filter must be in place, or it may lead to leakage.

Many problems which occur can be resolved by yourself without specific expertise. In case of a problem, please check all shown possibilities and follow below instructions before you contact customer service. See CUSTOMER SERVICE.



WARNING!

- ▶ Before maintenance, deactivate the appliance and disconnect the mains plug from the mains socket.
- ▶ Electrical equipment should be serviced only by qualified electrical experts, because improper repairs can cause considerable consequential damages.
- ▶ A damaged power cable should only be replaced by the manufacturer, its service agent or similarly qualified persons in order to avoid a hazard.
- ▶ For the safety of the end-user, self-repair or non-professional repair is not recommended. Please contact customer service.

9.1 Troubleshooting with display code

Problem	Cause	Solution
CLR FLTR	• Drainage error, water is not fully drained within 6 minutes.	<ul style="list-style-type: none"> • Clean pump filter. • Check drain hose installation.
E2	• Lock error.	<ul style="list-style-type: none"> • Shut the door properly.
E4	<ul style="list-style-type: none"> • Water level not reached after 12 minutes. • Drain hose is self-syphoning. 	<ul style="list-style-type: none"> • Make sure that tap is fully opened and water pressure is normal. • Check drain hose installation.
E8	• Water protective level error.	<ul style="list-style-type: none"> • Contact customer service.
E5	• Drainage error. Water is not fully drained in set time.	<ul style="list-style-type: none"> • Clean pump filter. • Check drain hose installation.
F3	• Temperature sensor error .	<ul style="list-style-type: none"> • Contact customer service.
F4	• Heating error.	<ul style="list-style-type: none"> • Contact customer service.
F7	• Motor error.	<ul style="list-style-type: none"> • Contact customer service.
FA	• Water level sensor error.	<ul style="list-style-type: none"> • Contact customer service.
FH	• The Wi-Fi module fails to be configured	<ul style="list-style-type: none"> • Contact customer service.
F0	• Water overflowed abnormally.	<ul style="list-style-type: none"> • Open drain pump to drain. Shut down the machine. Contact customer service.
FC0/FC1/ FC2	• Abnormal communication error.	<ul style="list-style-type: none"> • Contact customer service.
FC28	• The 12V load control board communication abnormality.	<ul style="list-style-type: none"> • Check the stepper motor drive board or connecting harness

Problem	Cause	Solution
FCU	<ul style="list-style-type: none"> Signal transmission error between the display board and the flow board 	<ul style="list-style-type: none"> Check the wiring connection between the UI and WP panel, check the UI panel.
nd	<ul style="list-style-type: none"> Model has not been selected 	<ul style="list-style-type: none"> Set the machine model
Lock	<ul style="list-style-type: none"> The water level, temperature, or spin speed does not meet the requirements for opening the door 	<ul style="list-style-type: none"> Contact customer service.
Eb	<ul style="list-style-type: none"> Laundry is caught in the door when closed. 	<ul style="list-style-type: none"> Please open the door and put the clothes into the drum completely. Then press the "Start" button to run the cycle.

9.2 Troubleshooting without display code

Problem	Cause	Solution
Washing machine fails to operate.	<ul style="list-style-type: none"> • Cycle is not yet started. • Door is not properly closed. • Machine has not been switched on • Power failure. • Key lock is activated 	<ul style="list-style-type: none"> • Check cycle and start it. • Close the door properly • Switch the machine on. • Check power supply. • Deactivate key lock.
Washing machine can not be filled with water.	<ul style="list-style-type: none"> • No water. • Inlet hose is kinked. • Inlet hose filter is blocked. • Water pressure is less than 0.05 MPa • Door is not properly closed • Water supply failure. 	<ul style="list-style-type: none"> • Check water tap. • Check inlet hose. • Unblock inlet hose filter. • Check water pressure. • Close the door properly. • Ensure the water supply.
Machine is draining while being filled.	<ul style="list-style-type: none"> • Height of drain hose is below 60 cm • Drain hose end could reach into water. 	<ul style="list-style-type: none"> • Make sure that drain hose is properly installed. • Make sure the drain hose is not in water.
Drainage failure	<ul style="list-style-type: none"> • Drain hose is blocked • Pump filter is blocked. • Drain hose end is higher than 100 cm above floor level 	<ul style="list-style-type: none"> • Unblock drain hose. • Clean pump filter. • Make sure that drain hose is properly installed
Strong vibration while spinning	<ul style="list-style-type: none"> • Not all transportation bolts have been removed • Appliance is not on solid and flat ground. • Something wrong with the load. 	<ul style="list-style-type: none"> • Remove all transportation bolts • Ensure solid and flat ground. • Check load weight and balance
Operation stops before wash cycle ends.	<ul style="list-style-type: none"> • Water or electric failure. 	<ul style="list-style-type: none"> • Check power and water supply.
Operation stops for a period of time.	<ul style="list-style-type: none"> • Appliance displays error code • Problem due to load pattern • During soaking process. 	<ul style="list-style-type: none"> • Consider display codes • Reduce or adjust load. • Cancel cycle and restart
Excessive foam overflows drum and/or detergent drawer.	<ul style="list-style-type: none"> • Detergent is not appropriate. • Excessive use of detergent. 	<ul style="list-style-type: none"> • Check detergent recommendations. • Reduce amount of detergent.
Automatic adjustment of washing time.	<ul style="list-style-type: none"> • Cycle duration can change automatically. 	<ul style="list-style-type: none"> • This is normal and doesn't affect functionality.

Problem	Cause	Solution
Spinning fails.	<ul style="list-style-type: none"> • Unbalance of laundry. 	<ul style="list-style-type: none"> • Check machine load and laundry and run a spinning cycle again.
Unsatisfactory washing result.	<ul style="list-style-type: none"> • Degree of soil does not match with selected cycle. • Detergent quantity was not sufficient. • Maximum load has been exceeded. • Laundry was unevenly distributed in the drum. 	<ul style="list-style-type: none"> • Select another cycle. • Choose the detergent according to the degree of soil and according to manufacture specifications. • Reduce loading. • Loosen the laundry.
Washing powder residues are on the laundry.	<ul style="list-style-type: none"> • Insoluble particles of detergent can remain as white spots on the laundry. 	<ul style="list-style-type: none"> • Perform extra rinse. • Try to brush the residues from the laundry. • Choose another detergent.
Laundry has grey patches.	<ul style="list-style-type: none"> • Caused by fats such as oils, creams or ointments. 	<ul style="list-style-type: none"> • Pretreat the laundry with a special cleaner.

i Note: Foam formation

If too much foam is inspected during spin cycle, the spin stage will stop and the drain pump will be activated for 90 seconds. This process will be repeated 3 times. If the foam is not eliminated after 3 attempts, the cycle will end without spinning.

Should the error messages reappear even after the taken measures, switch off the appliance, disconnect the power supply and contact the customer service.

9.3 In case of power failure

The current cycle and its setting will be saved.

When power supply is restored, operation will be resumed.

In case of an emergency (such as an power failure, and the door is locked), you can manually open the door lock and remove your load. In order to do that, water level needs to be lowered as described in "Pump filter". Then pull lever (A) until door is unlocked with a gentle click.

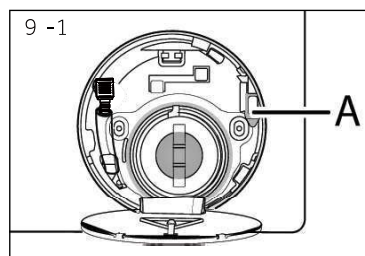

i When the washing machine is in a safe state (water level below the window with a certain distance, drum temperature below 55°C, drum is not spinning), can unlock the door.

10.1 Preparation

- ▶ Take the appliance out of the packaging.
- ▶ Remove all packaging material including the protective film on cabinet and the polystyrene base. Keep all packaging out of children's reach. While opening the package, water drops may be seen on plastic bag and sight window. This normal phenomenon results from watertests in the factory.



Note: Packaging disposal

Keep all packaging materials out of children's reach and dispose them in an environmentally friendly manner.

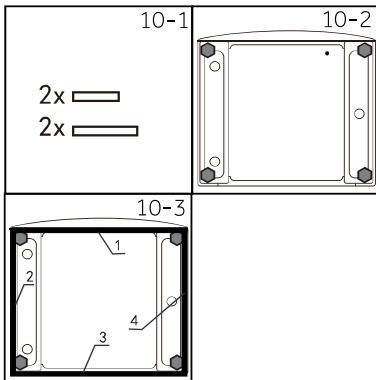

10.2 OPTIONAL: Install noise reduction pads

1. When opening the shrink package, you will find four noise reduction pads. These are used for reducing noise (Fig. 10-1).
 2. Lay the washing machine down to its back, with the washing machine door pointing upwards and the base of the product towards the installer (Fig. 10-2).
 3. Take out the noise reduction pads and remove the double-sided adhesive protective film; paste around the bottom; the noise reduction pads under the washing machine cabinet as shown in Figure 10-3 (two longer pads in position 1 and 3, two shorter pads in position 2 and 4).
- Finally set the machine upright again (Fig. 10-3).

Warm tip:

Noise reduction pad is optional, which could help to reduce noise. Please assemble it or not according to your own demand.

10.3 Dismantle the transportation bolts

The transportation bolts are designed for clamping anti-vibration components inside the appliance during transportation to prevent internal damage.

1. Remove all 4 bolts on the rear side and take out plastic spacers (Fig. 10-4) (Fig. 10-5).
2. Fill the holes with blanking plugs (Fig. 10-6) (Fig. 10-7).

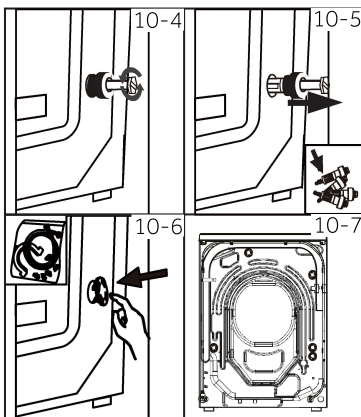

i Note: Keep in safe place

Keep all parts of the transport protection in a safe place for later use. Whenever the appliance is to be moved, reinstall the protection parts first.

10.4 Moving the appliance

If the machine is to be moved to a distant location, reinstall the transportation bolts in reverse order.

10.5 Levelling the appliance

Adjust all feet (Fig.10-8) to achieve a complete level position. This will minimize vibrations and thus noise during use. It will also reduce wear and tear. We recommend to use a spirit level for adjustment. Floor should be as stable and flat as possible.

1. Loosen the locknut (1) with a wrench.
2. Adjust the height by turning the foot (2).
3. Tighten locknut (1) against the housing.

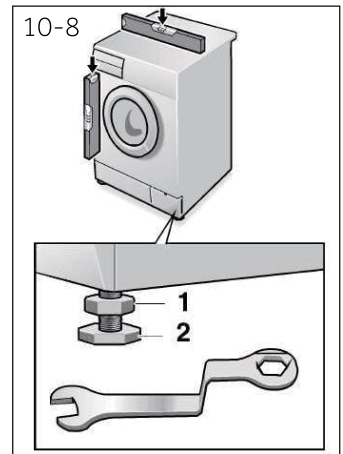

10.6 Drain Water Connection

Fix the water drain hose properly to the piping. The hose has to reach at one point a height between 60 and 100 cm above the appliance base! If possible, always keep the drain hose fixed to the clip at the back of the appliance.



WARNING!

- ▶ Use only the supplied hose set for the connection.
- ▶ Never reuse old hose sets!
- ▶ Only connect to cold water supply.
- ▶ Before connection, check whether the water is clean and clear.

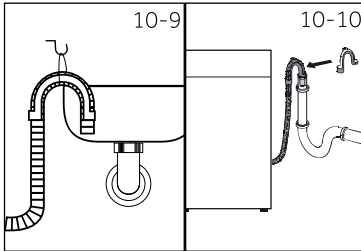

Following connections are possible:

10.6.1 Drain hose to sink

- ▶ Hang the drain hose with the U-support over the edge of a sink with adequate size (Fig.10-9).
- ▶ Protect the U-support sufficiently against slipping.

10.6.2 Drain hose to waste water connection

- ▶ The internal diameter of the stand pipe with vent-hole must be minimum 40 mm.
- ▶ Put the drain hose for 60- 100 mm in the wastewater pipe.
- ▶ Attach the U-support and secure it sufficiently (Fig. 10-10).

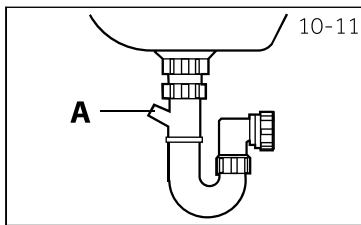

10.6.3 Drain hose to sink connection

- ▶ The junction must lie above the siphon.
- ▶ A spigot connection is usually closed by a pad (A). That must be removed to prevent any disfunction (Fig.10- 11).
- ▶ Secure the drain hose with a clamp.



CAUTION!

- ▶ The drain hose should not be submerged in water and should be securely fixed and leak-free. If the drain hose is placed on the ground or if the pipe is at a height of less than 60 cm, the washing machine will continuously drain while being filled (self-siphoning).
- ▶ Drain hose is not to be extended. If necessary contact customer service.

10.7 Fresh Water Connection

Make sure that the gaskets are inserted.

1. Connect the water inlet hose with the angled end to the appliance (Fig.10-12). Tighten the screw joint by hand.
2. The other end connect to a water tap with a 3/4" thread (Fig.10-13).

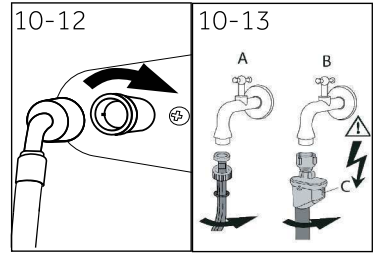

10.8 Electrical Connection

Before connection check if:

- ▶ power supply, socket and fuse are appropriate to the rating plate.
- ▶ the power socket is earthed and no multi-plug or extension is being used.
- ▶ the power plug and socket are matched.
- ▶ Put the plug into the socket(Fig. 10-14).

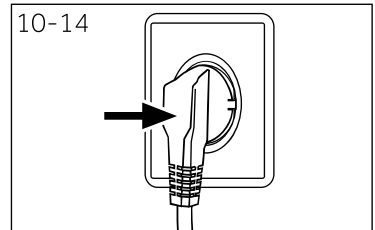

WARNING!

- ▶ Ensure always that all connections (power supply, drain and fresh water hose) are firm,dry and leak free!
- ▶ Make sure that these parts are never crushed, kinked or twisted.
- ▶ If the supply cord is damaged, it must be replaced by the service agent (see warranty card) in order to avoid a hazard.

11.1 Additional technical data

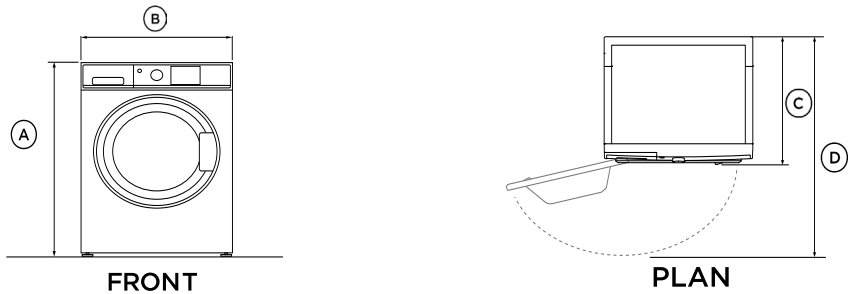

PRODUCT DIMENSIONS(MM)	HWF75K	HWF85K
(A) Overall height*		
• Min	850	850
• Max	865	865
(B) Overall width	595	595
(C) Overall depth**	507	565
(D) Depth with door open	992	1051

* Exact height is dependent on foot adjustment

**Including dial and door (when closed)

Actual product dimensions may vary by ± 2 mm.

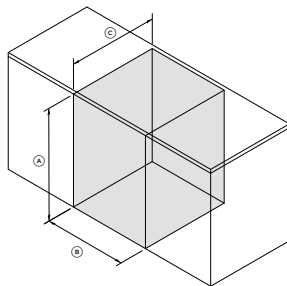

ISOMETRIC

* Front panel of the product

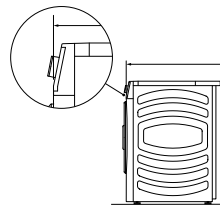

CAVITY DIMENSIONS	HWF75K	HWF85K
(A) Minimum cavity height	865	865
(B) Minimum cavity width	622	622
(C) Minimum cavity depth		
• Flush with front panel of the product*	523	581
• In cupboard	577	635

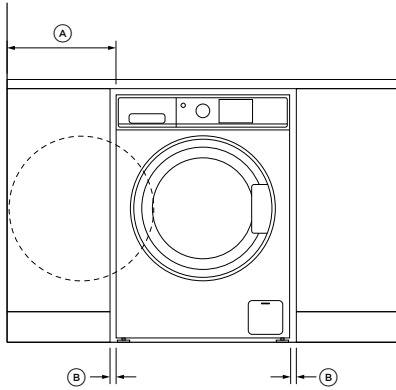

FRONT

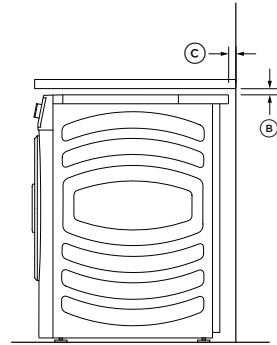

PROFILE

CLEARANCE DIMENSIONS

MM

Ⓐ Minimum washer door clearance to adjacent wall	240
Ⓑ Minimum gap clearance to adjacent product or cabinetry*	15
Ⓒ Minimum gap clearance to the adjacent wall or cabinetry	30

ELECTRICAL

Volts	220-240V
Hz	50
Amps(maximum)	10A
Power consumption(w)	1950(85)/1900(75)

Note: The exact height of your washer is dependent on how far the feet are extended from the base of the machine. The space where you install your washer needs to be at least 40mm wider and 20mm deeper than its dimensions.

We recommend our Haier Customer Service and the use of original spare parts. If you have a problem with your appliance, please first check the section TROUBLESHOOTING.

If you cannot find a solution there please contact:

- ▶ your local dealer, or
- ▶ The Service and Support area at www.haier.com where you can find telephone numbers, FAQs and where you can activate a service claim.

Before contacting our service team, ensure that you have the following information available.

The information can be found in the rating plate.

Model _____ Serial No. _____

Also check the Warranty Card supplied with the product in case of warranty. For General business enquiries and for more information, please refer to www.haier.com

Haier



0020509288JM