

WALL RANGEHOOD, BOX CHIMNEY

HC60BLX1 & HC90BLX1

**USER GUIDE
INSTALLATION GUIDE
NZ AU**

CONTENTS

Safety and warnings	3
Installation instructions	5
Operating instructions	17
Cleaning and maintenance	18
Parts and accessories	20
Manufacturer's Warranty	22
Customer Care	24

IMPORTANT!

SAVE THESE INSTRUCTIONS

The models shown in this user guide may not be available in all markets and are subject to change at any time. For current details about model and specification availability in your country, please go to our website www.fisherpaykel.com or contact your local Fisher & Paykel dealer.

Registration

Register your product with us so we can provide you with the best service possible.

To register your product visit our website: www.fisherpaykel.com

SAFETY AND WARNINGS

WARNING!



12 kg
(HC60)
15 kg
(HC90)

Weight Hazard

The rangehood is heavy. Please ensure adequate care is taken when installing the rangehood to prevent personal injury. The rangehood must be installed onto a solid wall, stud, beam or truss. Weight of the HC60BLX1 is 12 kg and weight of HC90BLX1 is 15 kg.

WARNING!



Electric Shock Hazard

Always disconnect the appliance from the mains power supply before carrying out any maintenance or repairs. Alterations to the domestic wiring system must be made by a qualified electrician. Failure to follow this advice may result in electric shock or death.

IMPORTANT SAFETY INSTRUCTIONS

WARNING! When using this appliance always exercise basic safety precautions including the following:

- Please read the entire set of instructions before installing or using this appliance.
- Please make this information available to the person installing the appliance - doing so could reduce your installation costs.
- Always switch the power off prior to installation, servicing or cleaning of the rangehood.
- This appliance must be installed and connected to the mains power supply only by a suitably qualified person according to these installation instructions and in compliance with any applicable local building and electricity regulations. Failure to install the appliance correctly could invalidate any warranty or liability claims.
- To comply with electrical safety regulations, the rangehood must be plugged into a socket near the appliance. The socket must be accessible, or have an accessible isolating switch, to enable the end user to isolate the rangehood from the power for the purpose of internal cleaning or maintenance.
- A power outlet should be within the range that does not affect installation and use of the motor assembly and can either be on the wall, behind the chimney or in the ceiling.
- If the supply cord of this equipment is damaged, it must only be replaced by the manufacturer, its service agent or similarly qualified person in order to avoid a hazard.
- Ducting accessories are not supplied. All ducting must comply with local requirements and building codes.
- Attention should be given to ensure that any applicable regulations concerning the discharge of exhaust air are fulfilled.
- Before connecting any pipes, consult municipal ordinances to ensure that any applicable regulations concerning the discharge of exhaust air are adhered to and request permission from the person in charge of the building.

SAFETY AND WARNINGS

- Exhaust air must not be discharged into an existing flue that is used for exhausting fumes from appliances burning gas or other fuels. Range hoods and other cooking fume extractors may adversely affect the safe operation of appliances burning gas or other fuels (including those in other rooms) due to back flow of combustion gases. These gases can potentially result in carbon monoxide poisoning. After installation of a range hood or other cooking fume extractor, the operation of flued gas appliances should be tested by a competent person to ensure that back flow of combustion gases does not occur.
- The minimum distance between the supporting surface for cooking vessels on the cooktop and the lowest part of the rangehood shall be 600 mm or 650 mm if installed over a gas cooktop.
- Stainless steel is very easily damaged during installation if abraded or knocked by tools. It is recommended to protect the top of the rangehood with cardboard or polystyrene during the installation to minimise the risk of damage occurring.
- To reduce the risk of damage occurring to the cooktop, it is recommended that the surface of the cooktop is protected with cardboard or a similar object during installation of the rangehood.
- This appliance is not intended for use by persons (including children) with reduced physical, sensory or mental capabilities, or lack of experience and knowledge, unless they have been given supervision or instruction concerning the use of the appliance by a person responsible for their safety.
- Children should be supervised to ensure they do not play with the appliance. Cleaning and user maintenance shall not be made by children without supervision.
- You must read the details concerning the method and frequency of cleaning.
- There is a fire risk if cleaning is not carried out in accordance with the instructions.
- Never leave frying food unattended since grease can overheat and catch fire. The risk of fire is even greater in the case of used oil.
- Do not flambé under the rangehood.
- Never use the rangehood without the filters in place.
- During an electrostatic discharge (ESD) it is possible that the device will stop working. By switching the device off and on the device will again work as intended.
- **CAUTION:** accessible parts may become hot when used with cooking appliances.
- Remove all packaging, including protective wrappings, before use.

INSTALLATION INSTRUCTIONS

Contents of packaging

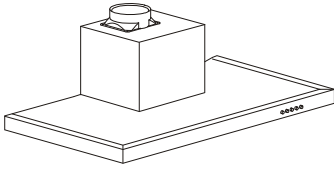

Cooker Hood (1)

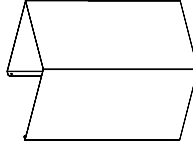

Outside chimney (1)

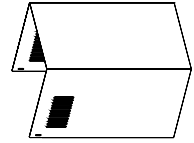

Inside chimney (1)

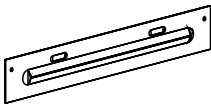

Outside chimney
bracket (1)

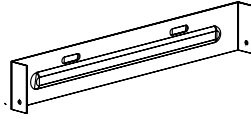

Inside chimney
bracket (1)

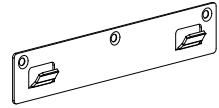

Hood mounting
bracket (1)

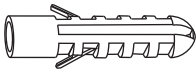

Wall plug (9)

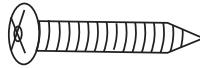

Countersunk Screw
(ST4*40mm) (7)

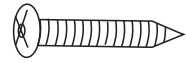

Pan head Screw
(ST4*30mm) (2)

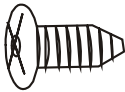

Screw (ST4 x 8mm) (4)

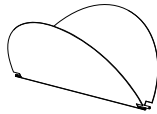

V-flap (150) (1 pair)



Cable tie (1)

INSTALLATION INSTRUCTIONS

Optional Recirculation Accessories

(when ducting externally not possible)

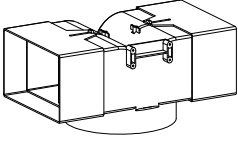

T-shaped plastic outlet (1)

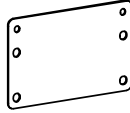

Installation bracket (1)

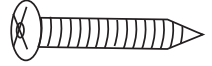

Screw ST3*12mm (6)



Screw ST4*8mm (2)

Recirculation Carbon filters



Carbon filter (2)

Not Included – available separately
See Parts and Accessories section for ordering details

INSTALLATION INSTRUCTIONS

Product dimensions

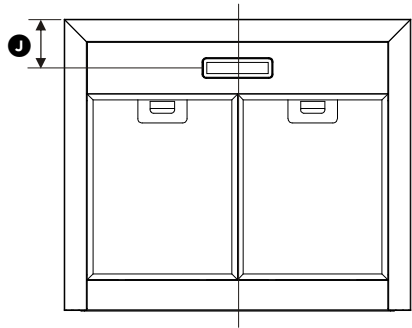
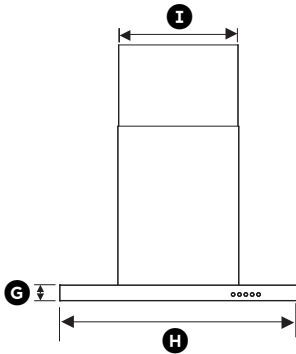
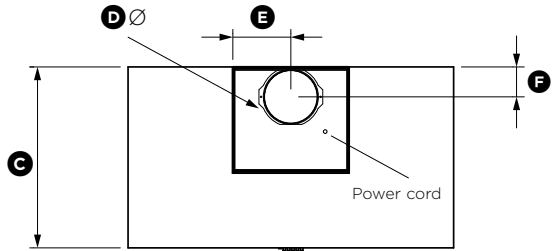
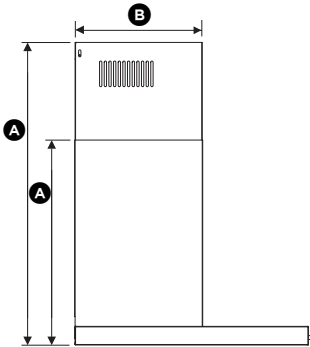

PRODUCT DIMENSIONS	HC60BLX1	HC90BLX1
	mm	mm
Ⓐ Overall height of product	min. 540-max. 1020	min. 540-max. 1020
Ⓑ Depth of chimney	275	275
Ⓒ Overall depth of product	500	500
Ⓓ Diameter of ducting outlet	150	150
Ⓔ Distance from centre of ducting outlet to side of chimney	152	152
Ⓕ Distance from centre of ducting outlet to back of product	80	80
Ⓖ Height of product	40	40
Ⓗ Overall width of product	598	898
Ⓘ Width of chimney	303	303
⓵ Distance between centre of lights to back of product	85	85

IMPORTANT!

Actual product dimensions may vary by ± 2 mm.

Please read the entire instructions before installing the rangehood.

INSTALLATION INSTRUCTIONS

Height of rangehood

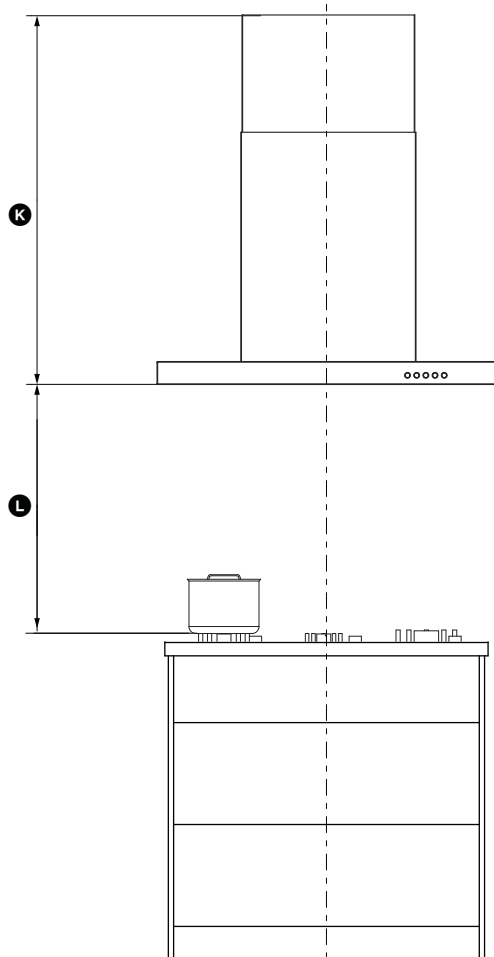

INSTALLATION DIMENSIONS

mm

Ⓚ Installation height	Ducted	min.540 - max.1020
	Recirculation	min.640 - max.1020
Ⓛ Height top of cooktop to base of product	Electric cooktop	min.600 - max.750
	Gas cooktop	min.650 - max.750

Rangehood installation height above the cooktop is the user's preference. Lower installation heights will improve the efficiency of capturing cooking odours, grease, and smoke. This rangehood must be installed between the minimum and maximum dimensions indicated in the table above.

Minimum installation height may be greater if required by the cooktop, refer to your cooktop installation instructions.

INSTALLATION INSTRUCTIONS

Venting options

Attention should be given to ensure that any applicable regulations concerning the discharge of exhaust air are fulfilled.

The rangehood can be installed to operate with the exhaust air ducted externally from the kitchen, or installed to operate with the exhaust air recirculating within the kitchen.

Ducted

For ducted installation it is recommended that 150 mm diameter, rigid or semi-rigid ducting is used. This will require a 160 mm (min) round hole in the ceiling or wall. Care should be taken to position the hole correctly.

For optimal efficiency use the shortest and straightest duct route possible and use rigid or semi-rigid ducting for reduced noise and increased airflow. Flexible metal ducting should only be used as a last resort (ie in difficult installations) and if used ensure that it is straight and smooth and extended as much as possible.

Recirculating

To enable the product to operate with the air recirculating, please purchase a recirculation diverter and carbon filters (refer to the 'Parts and accessories' section). The recirculation diverter is required to channel the air out the side vents at the top of the chimney and the carbon filters are required to remove odours.

Note: a ducting hole is not required in the wall or ceiling if the rangehood is installed to operate with exhaust air recirculating.

INSTALLATION INSTRUCTIONS

WARNING!

- This product is heavy and requires two persons for installation.
- Installation work and electrical wiring must be done by qualified person(s) in accordance with all applicable codes and standards.
- Failure to install the screws or fixing device in accordance with these instructions may result in electrical hazards

IMPORTANT!

Wear gloves to protect against sharp edges.

The manufacturer is not liable for any damage caused by not following these instructions.

Installation

Ensure there is a power socket accessible behind the chimney.

- ① Preparing for installation:
Before installing your rangehood:
 - Please read the instructions carefully.
 - Unpack the rangehood.
 - Ensure that the voltage (V) and the frequency (Hz) indicated on the serial plate match the voltage and frequency at the installation site.
 - Check that all functions are working.
 - Check that the area behind the installation surface to be drilled is clear of any electrical cables or pipes, etc.
 - The rangehood surfaces can be damaged during installation if grazed or knocked by tools. Please take care to protect the surfaces during installation.
 - Protect the cooktop surface with cardboard, or the like, to prevent damage occurring whilst the rangehood is being installed above.
 - Temporarily mark the height of the bottom of the rangehood and the centre of the cooktop on the wall according to the information given in the 'Installation instructions - Height of rangehood' section.
 - The wall used for mounting the rangehood should have sufficient strength and a flat surface.
- ② Attach chimney brackets and rangehood mounting screws to the wall

There are two methods of installation possible. One uses the supplied bracket. The other method attaches the rangehood to screws directly.

- Attach the Inside chimney bracket and the Hood mounting bracket in the locations shown in pic 2. Use ST4*40mm screws.
- OR Attach the Inside chimney bracket and the two mounting screws in the locations shown in pic 3. Use ST4*40mm screws. Ensure that there is a 2-5mm gap between the screw head and the wall. See pic 1.

Use the wall plugs if required.

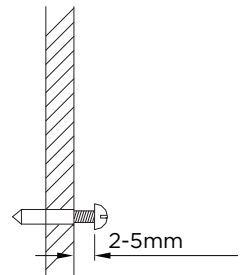

Pic 1

INSTALLATION INSTRUCTIONS

Bracket installation

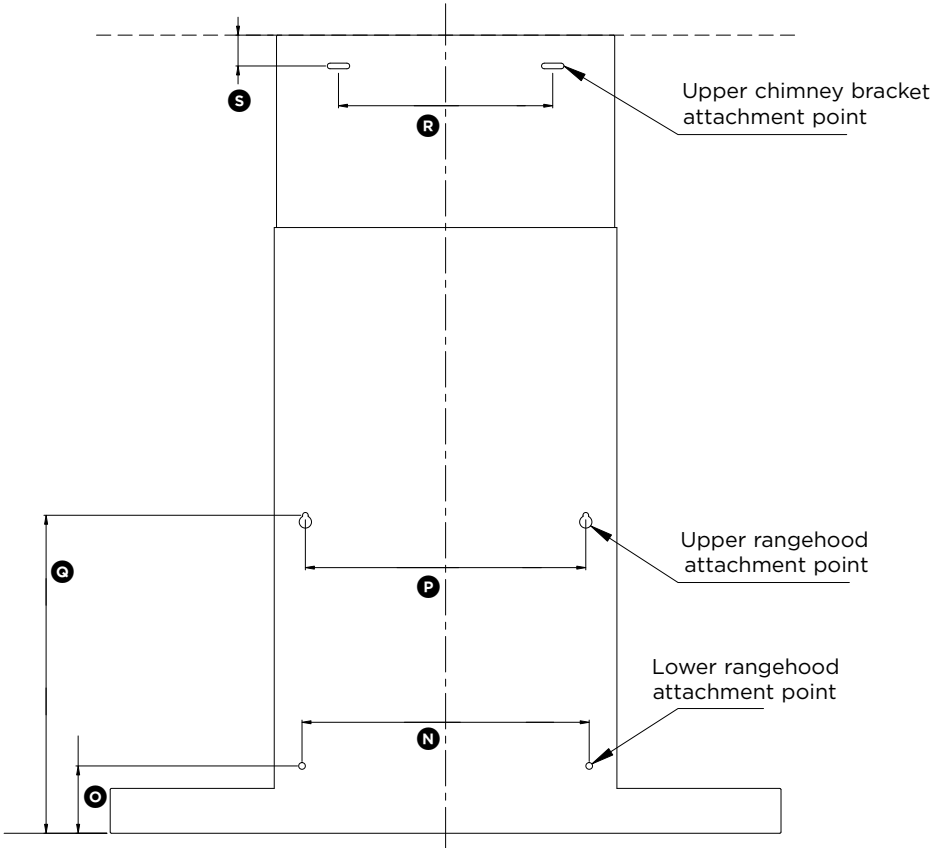

Pic 2

PRODUCT DIMENSIONS	HC60BLX1	HC90BL1X1
	mm	mm
(N) Lower rangehood attachment point width	256	256
(Q) Lower rangehood attachment point height	60	60
(P) Upper rangehood attachment point width	250	250
(G) Upper rangehood attachment point height	283.5	283.5
(R) Upper chimney bracket attachment point width	191	191
(S) Upper chimney bracket attachment point height	27.5	27.5

INSTALLATION INSTRUCTIONS

Screw Installation

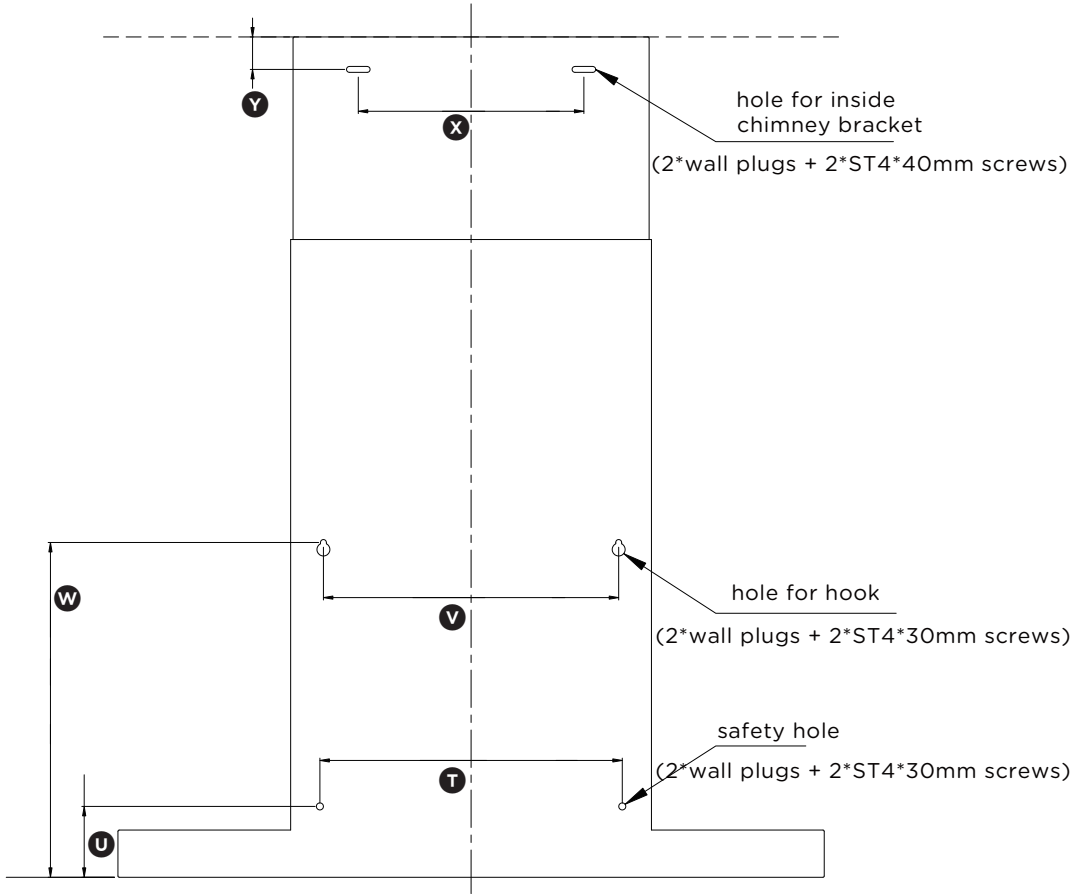

Pic 3

PRODUCT DIMENSIONS	HC60BLX1	HC90BL1X1
	mm	mm
Ⓣ Lower rangehood attachment point width	256	256
Ⓤ Lower rangehood attachment point height	60	60
Ⓥ Upper rangehood attachment point width	250	250
Ⓦ Upper rangehood attachment point height	283.5	283.5
ⓧ Upper chimney bracket attachment point width	191	191
Ⓨ Upper chimney bracket attachment point height	27.5	27.5

INSTALLATION INSTRUCTIONS

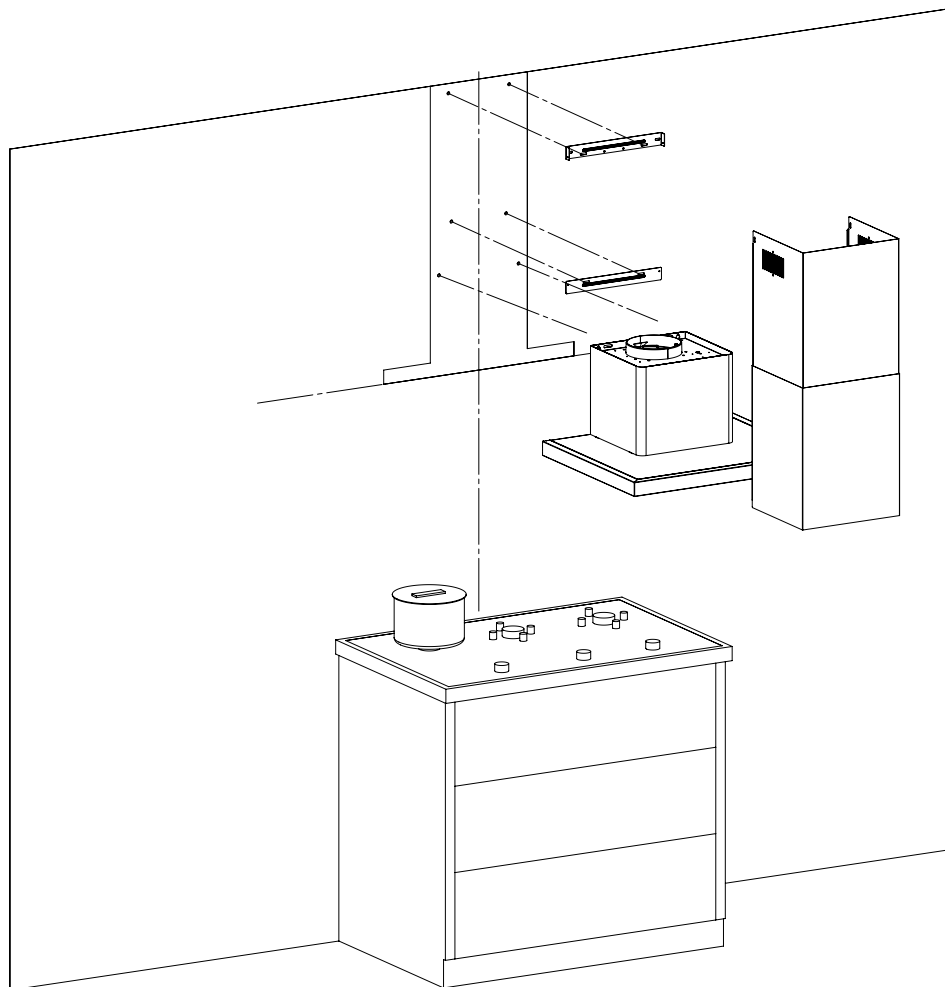

Pic 4

INSTALLATION INSTRUCTIONS

INSTALLATION (VENT OUTSIDE)

MOUNTING OF THE V-FLAP

If the cooker hood does not have an assembled V-flap 1, you should mount the half-parts to its body. The images only show an example of how to mount the V-flap, because the outlet may vary according to different models and configurations.

To mount the V-flap 1 you should:

- Mount two half-parts 2 into the body 6
- the pin 3 should be top oriented;
- the axis 4 should be inserted into the holes 5 on the body;
- repeat all the operations for the 2nd half-part

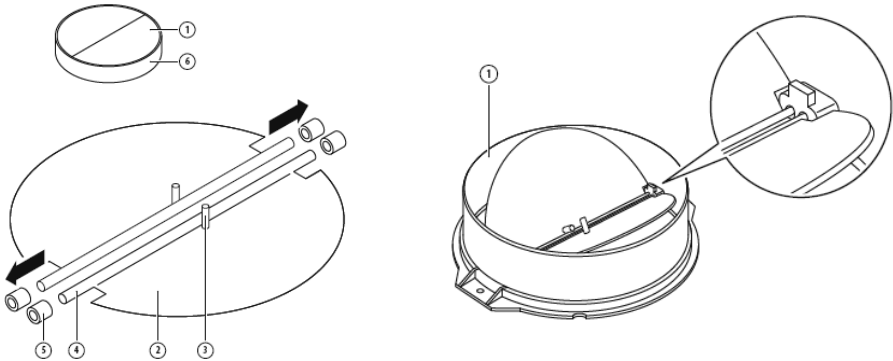

Pic 5

INSTALLATION

1. Fix the ducting with a cable tie on the hood outlet. See pic 6 and pic 7.
2. Fix the outside chimney bracket on the outside chimney with 2pcs ST4*8mm screws. Ensure that the inside chimney can slide up and down freely. See pic 8.

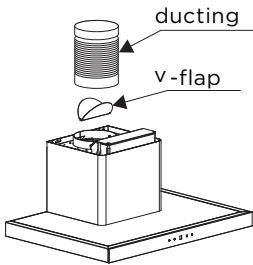

Pic 6

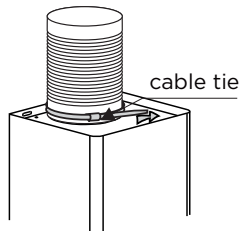

Pic 7

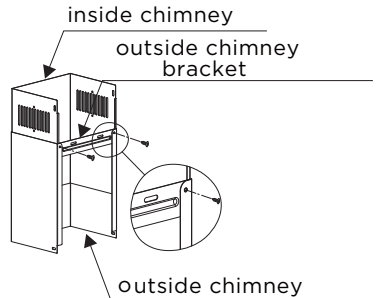

Pic 8

INSTALLATION INSTRUCTIONS

- Put the cooker hood on the hood bracket or on the two screws.
Tighten the two screws if needed. See pic 9.
- Adjust the position and fix the cooker hood body with the safety screws (2pcs ST4*30mm). See pic 10. Note: The 6mm holes for these two screws are positioned on the back of the cooker hood. They are accessible from underneath when the grease filters are removed.

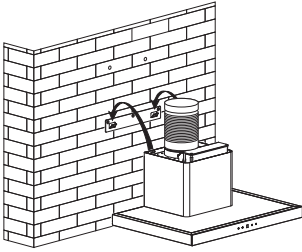

Pic 9

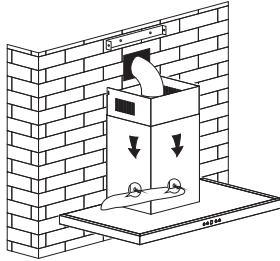

Pic 10

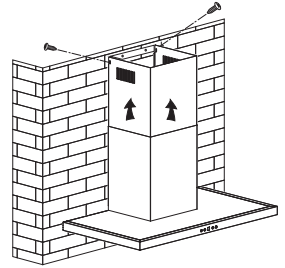

Pic 11

- Extend the ducting through the hole to the external vent.
- Plug the range hood in and turn the power on.
- Adjust the height of the inside chimney to the position of the inside chimney bracket and fix it with screws (2pcs ST4*8mm). See pic 11.

Recirculation Installation only (Accessory available)

Install the recirculation T-shaped plastic outlet

- Use 4 pcs ST3*12mm screws to attach the installation bracket onto the T-shaped plastic outlet. See pic 12.
- Adjust the width of the T-shaped plastic outlet to the width of the inside chimney and secure it using 2 pcs ST3*12mm screws. See pic 13.
- Use 2pcs ST4*8mm screws to fix the T-shaped plastic outlet to the Inside chimney bracket. See pic 13.
- Fix the Inside chimney bracket to the wall with 2pcs ST4*30mm screws. Use wall plugs if required. See pic 14.
- Secure the ducting to the inlet of the T-shaped plastic outlet.
- Adjust the height of the inside chimney and secure it to the Inside chimney bracket with 2pcs ST4*8mm screws. See pic 15, 16.

INSTALLATION INSTRUCTIONS

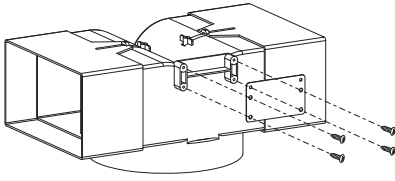

Pic 12

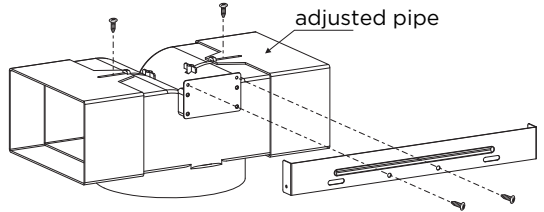

Pic 13

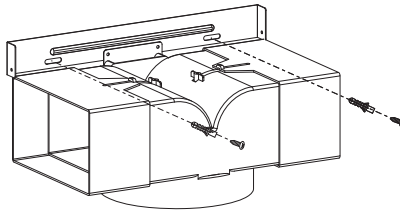

Pic 14

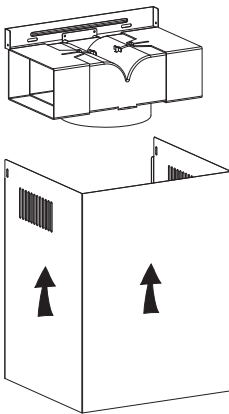

Pic 15

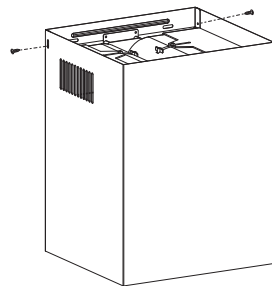

Pic 16

Start Using Your Cooker Hood

Push button

- 1) Push the “0” button, and the motor will stop.
- 2) Push the “1” button, and the motor will run at low speed.
- 3) Push the “2” button, and the motor will run at mid speed.
- 4) Push the “3” button, and the motor will run at high speed.
- 5) Push the light button and the light will illuminate. Push it again and the light will turn off.



CLEANING AND MAINTENANCE

WARNING!

Unplug or disconnect the appliance from the power supply before servicing or cleaning.

IMPORTANT!

- Never use abrasive or oil based cleaners.
- Wear gloves to protect against sharp edges.

Maintenance

The rangehood should be cleaned regularly using a mild, liquid detergent and a clean soft cloth to avoid a build-up of grease occurring. Avoid the use of corrosive chemicals, abrasive cleaning products, hard brushes and steel wool pads. Grease deposits are corrosive which can cause damage to your rangehood.

Note: in areas of high humidity or coastal environments, cleaning should be carried out more frequently.

GREASE MESH FILTERS

As needed the aluminium grease filters should be removed and cleaned with hot soapy water or washed separately in a dishwasher.

If washed in a dishwasher, the filter should be placed in an upright position. After rinsing and drying, replace the filters.

Note: Discolouration of the filters may occur.

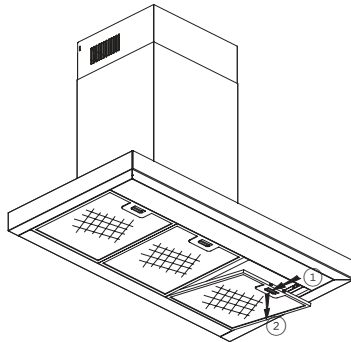

INSTALLING GREASE MESH FILTERS

- To install filters for the following four steps:
 1. Angle the filter into the slots at the back of the hood.
 2. Push the button on the handle of the filter.
 3. Release the handle once the filter fits into a resting position.
 4. Repeat to install all filters.

CLEANING AND MAINTENANCE

Carbon filters - for use in recirculation mode

Active carbon filters are disposable items designed to remove grease and odours from cooking vapours before the air is channelled back into the kitchen. The active carbon filters must be replaced periodically to work properly, at least every three months, depending on the frequency with which the rangehood is used.

Note: fully saturated carbon filters can become a barrier to air movement therefore limiting rangehood performance. In the event of fire, grease laden filters could be flammable and therefore regular replacement is recommended.

CARBON FILTER-not supplied

Activated carbon filter can be used to trap odors. Normally the activated carbon filter should be changed every 3 to 6 months according to your cooking habits. The installation procedure of activated carbon filter is as below:

1. Before installing or replacing the carbon filters, disconnect the mains power to the unit.
2. Press the filter lock and remove the mesh filter.
3. Turn the carbon filter on both sides of the motor anti-clockwise. Replace the carbon filters with the new carbon filters.
4. Replace the mesh filter.
5. Connect the power supply to the wall socket.

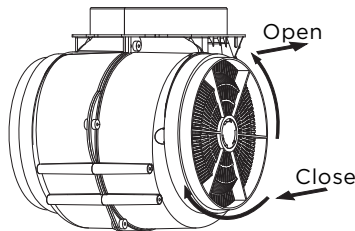

Replacing the LED light

Note: to replace the LED lights please refer to your nearest Fisher & Paykel trained and supported service technician, Customer Care, or contact us through our website:
www.fisherpaykel.com

PARTS AND ACCESSORIES

ITEM	REFERENCE NUMBER
LED lights	H0530061789
Aluminium filter	H0530061790
Recirculation carbon filter(×2)	H0530060509
T-shape Recirculation Outlet kit	H0530062211
Chimney Extension 900mm	'<\$)' \$\$* &&%&

MANUFACTURER'S WARRANTY

You automatically receive a 2 year Manufacturer's Warranty with the purchase of this rangehood covering parts and labour for servicing within the country of purchase.

Fisher & Paykel undertakes to:

Repair or, at its option, replace without cost to the owner either for material or labour any part of the product, the serial number of which appears on the product, which is found to be defective within TWO YEARS of the date of purchase.

Note: this Manufacturer's Warranty is an extra benefit and does not affect your legal rights.

This Manufacturer's Warranty DOES NOT cover

- Ⓐ Service calls which are not related to any defect in the product. The cost of a service call will be charged if the problem is not found to be a product fault. For example:
 - ① Correcting the installation of the product.
 - ② Instructing you how to use the product.
 - ③ Replacing house fuses or correcting house wiring or plumbing.
 - ④ Correcting fault(s) caused by the user.
 - ⑤ Noise or vibration that is considered normal, eg drain/fan sounds, refrigeration noises or user warning beeps.
 - ⑥ Correcting damage caused by pests, eg rats, cockroaches, etc.
 - ⑦ Replacement light bulbs.
- Ⓑ Defects caused by factors other than:
 - ① Normal domestic use; or
 - ② Use in accordance with the product's user guide.
- Ⓒ Defects to the product caused by accident, neglect, misuse or 'act of God'.
- Ⓓ The cost of repairs carried out by non-authorized repairers or the cost of correcting such unauthorised repairs.
- Ⓔ Normal recommended maintenance as set out in the product's user guide.
- Ⓕ Repairs when the appliance has been dismantled, repaired or serviced by other than a Fisher & Paykel Authorised Repairer or the selling dealer.
- Ⓖ Pick-up and delivery.
- Ⓗ Transportation or travelling costs involved in the repair when the product is installed outside the Fisher & Paykel Authorised Repairer's normal service area.

Nothing in this Manufacturer's Warranty is intended to, or does, limit any rights you may have under law to recover the costs of inspecting or returning the goods to us.

This product has been designed for use in a normal domestic (residential) environment. This product is not designed for any commercial use (whatsoever). Any commercial use by a customer will affect this product's Manufacturer's Warranty.

Service under this Manufacturer's Warranty must be provided by a Fisher & Paykel Authorised Repairer (refer to the 'Customer Care' section at the back of this book). Such service shall be provided during normal business hours. This Manufacturer's Warranty certificate should be shown when making any claim.

MANUFACTURER'S WARRANTY

For Australian Customers

This Manufacturer's Warranty is an extra benefit and does not affect your legal rights. Our goods come with guarantees that cannot be excluded under the Australian Consumer Law. You are entitled to a replacement or refund for a major failure and for compensation for any other reasonably foreseeable loss or damage. You are also entitled to have the goods repaired or replaced if the goods fail to be of acceptable quality and the failure does not amount to a major failure.

Please keep this user guide in a safe place.

CUSTOMER CARE

Before you call for service or assistance...

Check the things you can do yourself. Refer to the installation instructions and your user guide and check that:

- ① Your product is correctly installed.
- ② You are familiar with its normal operation.

If after checking these points you still need assistance or parts, please refer to your nearest Authorised Service Centre, Customer Care, or contact us through our website www.fisherpaykel.com.

In New Zealand if you need assistance...*

Call your Fisher & Paykel retailer who is trained to provide information on your appliance, or if we can be of any further help, please contact our Customer Care Centre.

Toll Free: 0800 FP CARE or 0800 372 273

Fax: (09) 273 0656

Website: www.fisherpaykel.com

Postal address: Fisher & Paykel Appliances Ltd, PO Box 58550, Botany, Auckland 2163

If you need service...*

Fisher & Paykel has a network of independent Fisher & Paykel Authorised Repairers whose fully trained technicians can carry out any service necessary on your appliance. Your dealer or our Customer Care Centre can recommend a Fisher & Paykel Authorised Repairer in your area.

In Australia if you need assistance...*

Call the Fisher & Paykel Customer Care Centre and talk to one of our Customer Care Consultants.

Toll Free: 1300 650 590

Fax: (07) 3826 9298

Website: www.fisherpaykel.com

Postal address: Fisher & Paykel Appliances Ltd, PO Box 798, Cleveland QLD 4163

If you need service...*

Fisher & Paykel has a network of Fisher & Paykel trained and supported service technicians responsible for servicing only Fisher & Paykel branded appliances. Our Customer Care Centre can recommend a Fisher & Paykel trained and supported service technician in your area.

*If you call, write or contact our website please provide: your name and address, model number, serial number, date of purchase and a complete description of the problem. This information is needed in order to better respond to your request for assistance.

Product details can be found under the aluminium filter.

Registration

Register your product with us so we can provide you with the best service possible. To register your product visit our website: www.fisherpaykel.com

CUSTOMER CARE

Complete and keep for safe reference:

Model _____

Serial No. _____

Purchase Date _____

Purchaser _____

Dealer _____

Suburb _____

Town _____

Country _____

© Fisher & Paykel Appliances 2015. All rights reserved.
The product specifications in this booklet apply to the specific products and models described at the date of issue. Under our policy of continuous product improvement, these specifications may change at any time. You should therefore check with your Dealer to ensure this booklet correctly describes the product currently available.

NZ AU

104033 A 10.15