

The Haier logo is displayed in white text on a dark grey rectangular background in the top right corner of the page.

Haier

Induction Cooktops

INDUCTION COOKTOPS

HCI905FTB4, HCI905FTG4, HCI905TPB4, HCI905TB4,
HCI604FTB4, HCI604FTPB4, HCI604FTG4

CONTENTS

Safety and warnings	4
Components required	7
Product specifications	
HCI905FTB4, HCI905FTG4, HCI905TPB4, HCI905TB4	8
HCI604FTB4, HCI604FTPB4, HCI604FTG4	9
Cavity specification	10
Clearances	11
Ventilation	12
Electrical specifications	13
Installation	15
Installer checklist	17

⚠ WARNING!



Electric Shock Hazard

Failure to follow this advice may result in electric shock or death.

- Disconnect the appliance from the mains electricity supply before carrying out any work or maintenance.
- Connection to a good earth wiring system is essential and mandatory.
- Alterations to the domestic wiring system must only be made by a qualified electrician.
- Do not cook on a broken or cracked cooktop. If the cooktop surface should break or crack, switch the appliance off immediately at the mains power supply (wall switch) and contact a qualified technician.

⚠ WARNING!



Cut Hazard

Failure to use caution could result in injury.

- Take care: some edges are sharp.
- The razor-sharp blade of a cooktop scraper is exposed when the safety cover is retracted. Use with extreme care and always store safely and out of reach of children.

⚠ WARNING!



Hot Surface Hazard

Failure to follow this advice may result in burns and scalds or serious injury.

- During use, accessible parts of this appliance will become hot enough to cause burns.
- Do not let your body, clothing or any item other than suitable cookware contact the ceramic glass until the surface is cool.
- Metallic objects such as knives, forks, spoons and lids should not be placed on the hob surface since they can get hot.
- Handles of saucepans may be hot to touch. Check saucepan handles do not overhang other cooking zones that are on. Keep handles out of reach of children.
- Keep children away.

SAFETY AND WARNINGS

READ AND SAVE THIS GUIDE

General Use

- Read these instructions carefully before installing this product.
- Never leave the appliance unattended when in use. Boil over causes smoking and greasy spillovers that may ignite.
- Never use your appliance as a work or storage surface.
- Never leave any objects or utensils on the appliance.
- Never use your appliance for warming or heating the room.
- After use, always turn off the cooking zones and the cooktop as described in this manual (i.e. by using the touch controls).
- Do not allow children to play with the appliance or sit, stand, or climb on it.
- Do not store items of interest to children in cabinets above the appliance. Children climbing on the cooktop could be seriously injured.
- Do not leave children alone or unattended in the area where the appliance is in use.
- Children or persons with a disability or lack of experience and knowledge, which limits their ability to use the appliance should have a responsible and competent person to instruct them in its use. The instructor should be satisfied that they can use the appliance without danger to themselves or their surroundings.
- Do not repair or replace any part of the appliance unless specifically recommended in the manual. All other servicing should be done by a qualified technician.
- Do not use a steam cleaner to clean your cooktop.
- Do not place or drop heavy objects on your cooktop.
- Do not stand on your cooktop.
- Do not use pans with jagged edges or drag pans across the Ceramic glass surface as this can scratch the glass.
- Do not use scourers or any other harsh abrasive cleaning agents to clean your cooktop, as these can scratch the Ceramic glass.
- If the supply cord is damaged, it must be replaced by the manufacturer, its service agent or similarly qualified persons in order to avoid a hazard.
- This appliance is not intended for use by persons (including children) with reduced physical, sensory or mental capabilities, or lack of experience and knowledge, unless they have been given supervision or instruction concerning use of the appliance by a person responsible for their safety.
- Children should be supervised to ensure that they do not play with the appliance.
- Cleaning and user maintenance shall not be made by children without supervision.
- The appliance is not intended to be operated by means of an external timer or separate remote-control system.
- **CAUTION:** The cooking process has to be supervised. A short term cooking process has to be supervised continuously.

Installation

- The cooktop must be installed by qualified personnel or technicians.
- Read these instructions carefully before installing or using this appliance.
- The bench top must be square and level, and no structural members should interfere with space requirements.
- The cooktop will not be installed directly above a dishwasher, fridge, freezer, washing machine or clothes dryer, as the humidity may damage the cooktop.
- If the cooktop is installed above an oven, the oven must have a built-in cooling fan.
- The installation will comply with all clearance requirements and applicable standards and regulations.
- The work surface must be made of a heat-resistant material.

SAFETY AND WARNINGS

- No combustible material or products should be placed on this appliance at any time.
- Please make this information available to the person responsible for installing the appliance as it could reduce your installation costs.
- In order to avoid a hazard, this appliance must be installed according to these instructions for installation.
- This appliance should be connected to a circuit which incorporates an isolating switch providing full disconnection from the power supply.
- Failure to install the appliance correctly could invalidate any warranty or liability claims.
- Use heat-resistant and easy-to-clean finishes (such as ceramic tiles) for the wall surfaces surrounding the hob.
- Consult local building authorities and by-laws if in doubt regarding installation.
- To avoid any damage, the foam seal and adhesive must be resistant to heat.

Electrical

- This cooktop must be connected to the mains power supply only by a suitably qualified person.
- This cooktop must be earthed by a suitably qualified person.
- A suitable isolating switch providing full disconnection from the mains power supply is incorporated in the permanent wiring, mounted and positioned to comply with the local wiring rules and regulations.
- The isolating switch must be of an approved type and provide a 3 mm air gap contact separation in all poles (or in all active [phase] conductors if the local wiring rules allow for this variation of the requirements).
- Before connecting the cooktop to the mains power supply, check that:
 - The domestic wiring system is suitable for the power drawn by the cooktop
 - The voltage corresponds to the value given on the rating plate
 - The power supply cable sections can withstand the load specified on the rating plate.
 - To connect the cooktop to the mains power supply, do not use adapters, reducers, or branching devices, as they can cause overheating and fire.
 - The power supply cable must not be kinked and should not be touching the underside of the cooktop which could get hot during operation.
 - If the cable is damaged or needs replacing, this should be done by an after-sales technician using the proper tools, so as to avoid any accidents.
 - If the appliance is being connected directly to the mains supply, an omnipolar circuit breaker must be installed with a minimum gap of 3mm between the contacts.
 - The installer must ensure that the correct electrical connection has been made and that it complies with safety regulations.
 - The cable must be checked regularly and only replaced by a properly qualified person.
 - The power supply should be connected in compliance with the relevant standard, or a single-pole circuit breaker. The method of connection is shown below.

Electromagnetic hazards

- This appliance complies with electromagnetic safety standards.
- However, persons with cardiac pacemakers or other electrical implants (such as insulin pumps) must consult with their doctor or implant manufacturer before using this appliance to make sure that their implants will not be affected by the electromagnetic field.
- Failure to follow this advice may result in death.

COMPONENTS REQUIRED

..... TOOLS

Not supplied

- Box cutter
- Phillips screwdriver
- Level

..... PARTS

Supplied and required

- 4 x Retaining brackets
- 4 x Bracket screws
- Foam tape (attached)

PRODUCT SPECIFICATIONS HCI905FT AND HCI905T MODELS

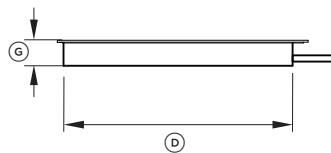
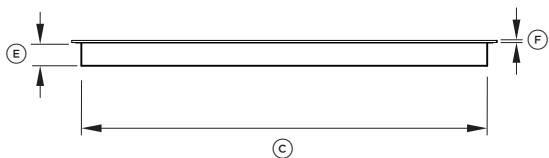
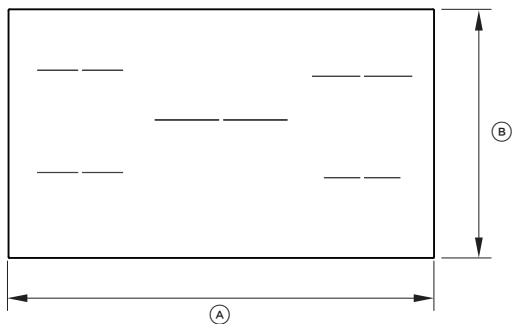

PRODUCT DIMENSIONS

MM

(A) Overall length of cooktop	900
(B) Overall width of cooktops	520
(C) Length of chassis	867
(D) Width of chassis	487
(E) Height of chassis (excluding glass)	56
(F) Height of cooktop glass	4
(G) Overall cooktop height	60

PRODUCT SPECIFICATIONS HCI604FT MODELS

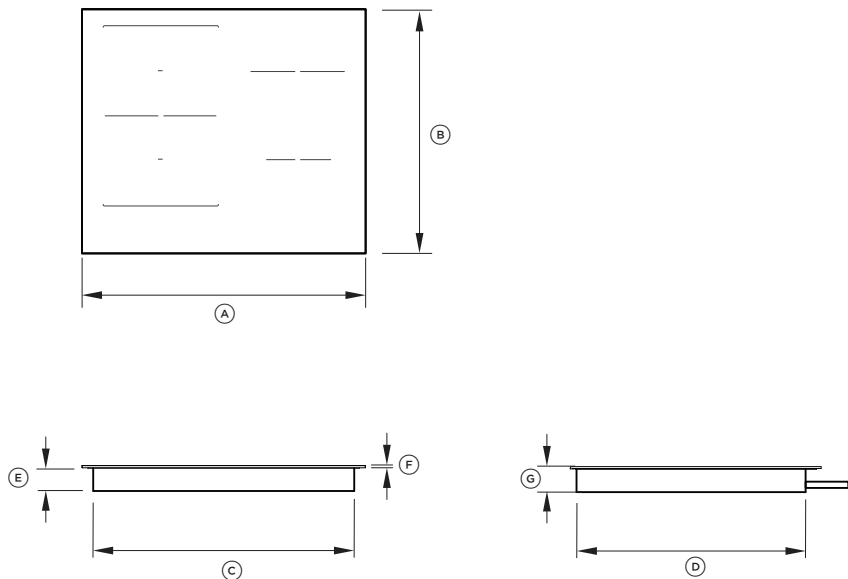

PRODUCT DIMENSIONS

MM

(A) Overall length of cooktop	590
(B) Overall width of cooktops	520
(C) Length of chassis	560
(D) Width of chassis	490
(E) Height of chassis (excluding glass)	56
(F) Height of cooktop glass	4
(G) Overall cooktop height	60

CAVITY SPECIFICATION

HCI905 Models

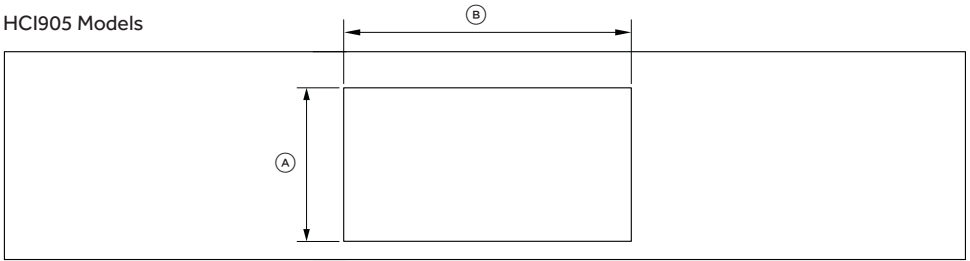

HCI604 Models

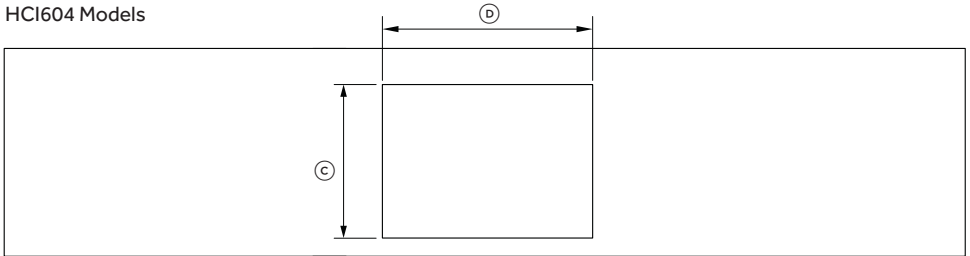

PRODUCT DIMENSIONS	MIN	MAX
HCI905 Models		
Ⓐ Width of cavity	488mm	490mm
Ⓑ Length of cavity	868mm	870mm
HCI604 Models		
Ⓒ Width of cavity	480mm	492mm
Ⓓ Length of cavity	560mm	562mm

CLEARANCES

Ensure all minimum specifications have been met and clearances have been considered.

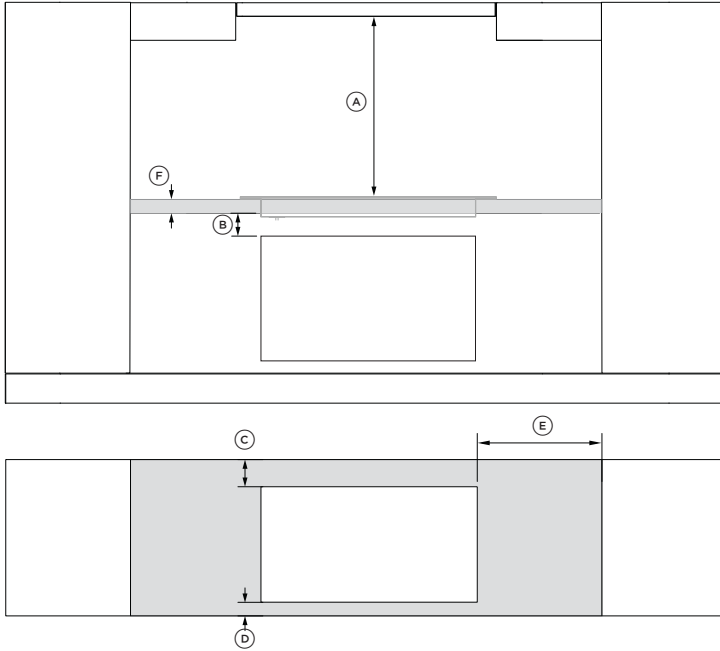

CLEARANCE DIMENSIONS	MM
Ⓐ Minimum clearance from glass surface to rangehood	600
Ⓑ Minimum clearance below cooktop chassis to any appliance, companion product or obstruction below cooktop*	50
Ⓒ Minimum clearance from rear edge of cut-out to nearest combustable surface	50
Ⓓ Minimum clearance from front edge of cut-out to front edge of counter	50
Ⓔ Minimum clearance from side edges of cut-out to nearest combustable surface	50
Ⓕ Minimum bench top thickness	18

*Clearance stated is for proud installation of the cooktop. For flush installations, the height of the cooktop glass should be added to the clearance.

VENTILATION

This cooktop requires adequate supply of cool air to fully function. The base of the cooktop must have direct unrestricted ventilation to the room where the cooktop is installed. There must be a 5mm air gap at the front of the cooktop.

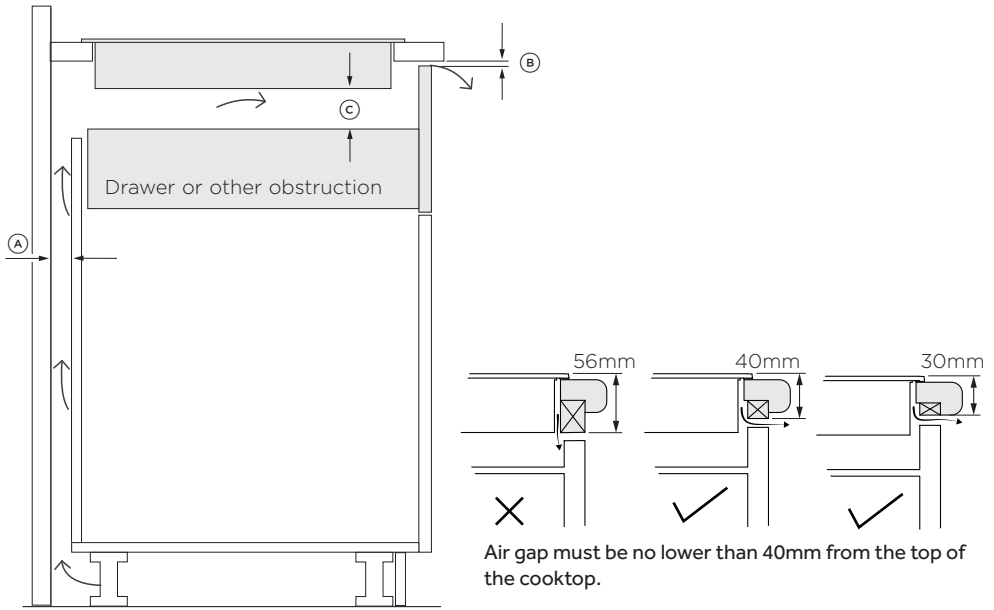

VENTILATION DIMENSIONS	MM
(A) Minimum ventilation gap at the rear of the cooktop	20
(B) Minimum ventilation gap at the front of the cooktop	5
(C) Minimum ventilation under the cooktop	50

*If ventilation gap at the rear of the cooktop is not possible, add two x 2" diameter (50mm) holes in the side wall to allow adequate cooling air.

ELECTRICAL SPECIFICATIONS

Connecting the cooktop to the mains power supply

IMPORTANT!

- This cooktop must be connected to the mains power supply only by a suitably qualified person.
- This cooktop must be earthed.
- Before connecting the cooktop to the mains power supply, check that:
 - The domestic wiring system is suitable for the power drawn by the cooktop
 - The voltage corresponds to the value given on the rating plate
 - The power supply cable sections can withstand the load specified on the rating plate.
- To connect the cooktop to the mains power supply, do not use adapters, reducers, or branching devices, as they can cause overheating and fire.
- The power supply cable must not be kinked and should not be touching the underside of the cooktop which could get hot during operation.
- If the cable is damaged or needs replacing, this should be done by an after-sales technician using the proper tools, so as to avoid any accidents.
- If the appliance is being connected directly to the mains supply, an omnipolar circuit breaker must be installed with a minimum gap of 3mm between the contacts.
- The installer must ensure that the correct electrical connection has been made and that it complies with safety regulations.
- The cable must be checked regularly and only replaced by a properly qualified person.
- The power supply should be connected in compliance with the relevant standard, or a single-pole circuit breaker. The method of connection is shown below.

IMPORTANT!

- Check with an electrician whether the domestic wiring system is suitable without alterations. Any alterations must only be made by a qualified electrician.

ELECTRICAL SPECIFICATIONS

SINGLE PHASE

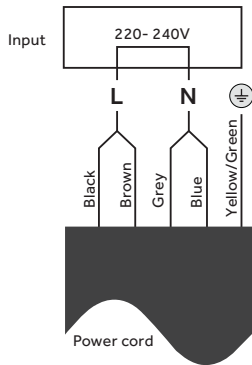

TWO PHASE

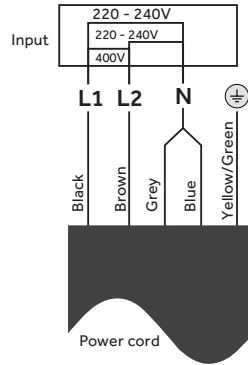

IMPORTANT!

- Check with an electrician whether the domestic wiring system is suitable without alterations. Any alterations must only be made by a qualified electrician.

INSTALLATION

①

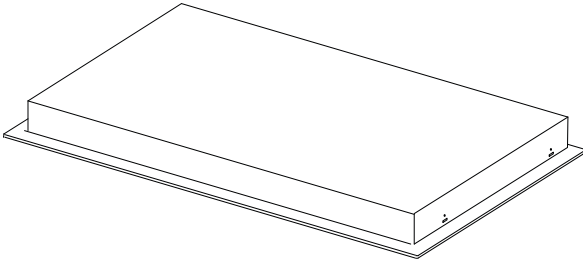

Turn the cooktop upside down on a protective cover.
Do not remove the foam seal under the edge of the glass top.

②

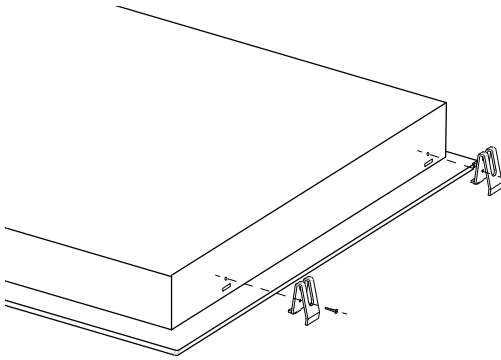

Fix the four supplied retaining brackets to cooktop.
Insert the tab into the side of the cooktop and screw the bracket in.

INSTALLATION

3

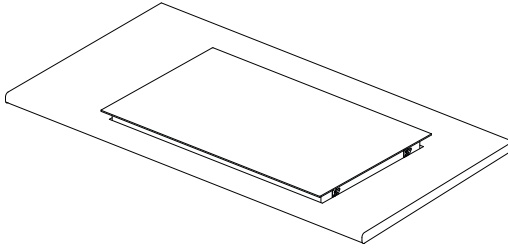

Connect the cooktop to the mains power.

Flip the cooktop and lower it into the bench cut-out.

4

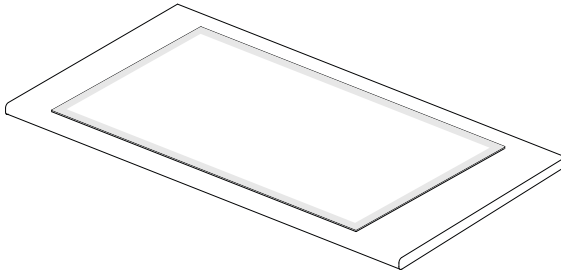

Press the glass edges onto the bench top.

INSTALLER CHECKLIST

GENERAL

- Read safety and warnings in the user guide before operating the cooktop.
- Specified clearance maintained.
- Unit is level - front to back and side to side.
- All packaging materials have been removed.
- There is constant flow of cool air from the cabinetry to the base of the cooktop.
- Basic operation has been demonstrated to the customer.
- The cooktop is functioning correctly. Turn on all zones to a high setting and leave on for at least one minute.
- Touch controls and displays are functioning.

ELECTRICAL

- Receptacle with correctly rated over-current protection is provided for service cord connection.
- Adequate ground connection.
- Power supply cable is accessible and is not touching the cooktop.

Complete and keep for safe reference:

Model _____

Serial no. _____

Purchase date _____

Purchaser _____

Dealer address _____

Installer's name _____

Installer's signature _____

Installation company _____

Installation date _____

Haier

WWW.HAIER.COM.AU
WWW.HAIER.CO.NZ

条形码尺寸40*8mm, 由厂家生成。

432498A | 10.24