

Valve Box Operation & Installation Manual

VP4-450B

No. 0150532477

- Please read this manual carefully before using
- Keep this operation manual for future reference

User Manual

This series is cooling and heating heat recovery models. Only when the system is equipped with valve box, indoor units under different valve boxes can achieve cooling and heating simultaneously. The modes of the indoors which under the same valve box should be the same. If the indoors connected without valve box, the indoors only can do cooling mode.

CONTENT

Parts and Functions.....	1
Safety	2
Installation instruction	4
Installation procedure	7
Electrical wiring.....	17
Initial setting.....	22
Commissioning	24

Parts and Functions

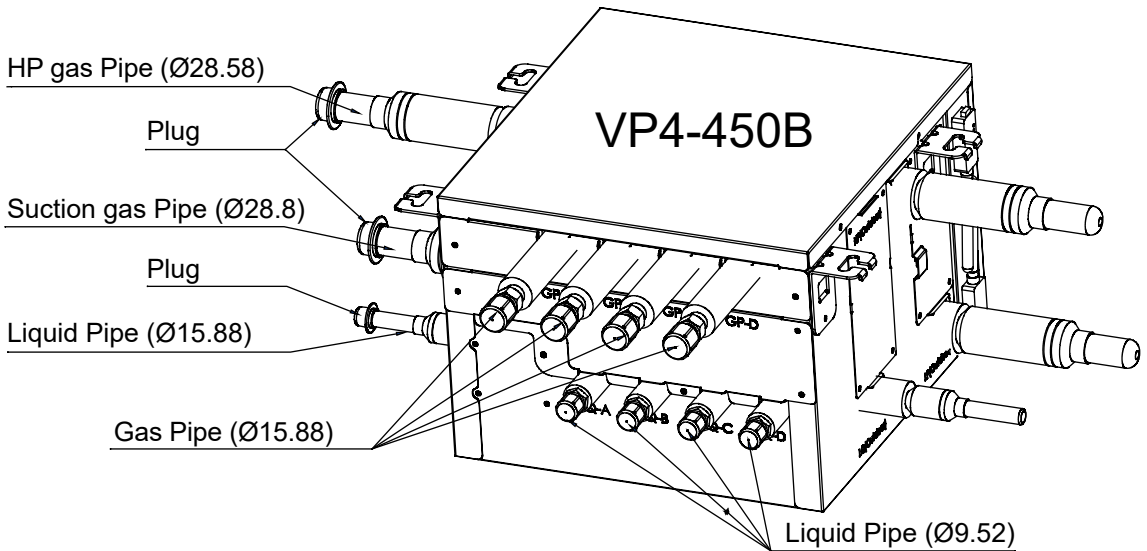

Before installation, be sure to remove the plug. When the valve box is connected with the outdoor unit, the left side of the three pipes or the right side of the three pipes can be selected according to the actual installation requirements. At the same time, the other end of the three tubes needs to be blocked.

Safety

- If the valve box is transferred to a new user, this manual shall be transferred to the user, together with the conditioner.
- Before installation, be sure to read Safety Considerations in this manual for proper installation.
- The safety considerations stated below is divided into “⚠Warning” and “⚠Attention”. The matters on severe accidents caused from wrong installation, which is likely to lead to death or serious injury, are listed in “⚠Warning”. However, the matters listed in “⚠Attention” are also likely cause the severe accidents. In general, both of them are the important items related to the security, which should be strictly abided by.
- After the installation, perform test run to make sure everything is in normal conditions, and then operate and maintain the valve box in accordance with the user manual. The user manual should be delivered to the user for proper keeping.

⚠Warning

- Please ask the special maintenance station for installation and repair. Water leakage, electric shocks or fire accidents might be caused from improper installation if you conduct the installation by your own.
- The installation should be conducted properly according to this manual. Water leakage, electric shocks or fire accidents might be caused from improper installation.
- Please make sure to install the valve box on the place where can bear the weight of the valve box. The valve box can't be installed on the grids such as the non-special metal burglar-proof net. The place with insufficient support strength might cause the dropdown of the machine, which may lead to personal injuries.
- The installation should be ensured against typhoons and earthquakes, etc. The installation unconformable to the requirements will lead to accidents due to the turnover of the machine.
- Specific cables should be used for reliable connections of the wirings. Please fix the terminal connections reliably to avoid the outside force applied on the cables from being impressed on the cables. Improper connections and fixings might lead to such accidents as heating or fire accidents.
- Correct shapes of wirings should be kept while the embossed shape is not allowed. The wirings should be reliably connected to avoid the cover and the plate of the electrical cabinet clipping the wiring. Improper installation might cause such accidents as heating or fire accidents.
- While placing or reinstalling the valve box, except the specific refrigerant (R410A), don't let the air go into the refrigeration cycle system. The air in the refrigeration cycle system might lead to the cracking or personal injuries due to abnormal high pressure of the refrigeration cycle system.
- During installation, please use the accompanied spare parts or specific parts. If not, water leakage, electric shocks, fire accidents or refrigerant leakage might be caused.
- During installation, if refrigerant leakage occurs, ventilation measures should be taken, for the refrigerant gas might generate harmful gases upon contacting the flame.
- After installation, check if any refrigerant leakage exists. If the refrigerant gas leaks in the room, such things as air blowing heaters and stoves, etc. may generate harmful gases.
- Don't install the valve box at the places where the flammable gases may leak. In case the gas leakage occurs around the machine, such accidents as fire disasters may be caused.
- The refrigerant gas pipe, HP gas pipe and liquid pipe should be heat insulated to preserve heat. For inappropriate heat insulation, the water caused from the condensation will drop to get the article at home wet.

Safety

- The electrical construction shall be implemented by the correspondingly qualified personnel in accordance with electrical construction standards, local electrical laws as well as specifications. Moreover, dedicated circuit must be used, rather than the wire pin. Insufficient capacity of the wire circuit and unprepared construction (if any) may cause electric shock, fires, etc.
- During the process of grounding, the ground wire cannot be connected to the gas pipe, water pipe, lightning rod and ground wire of the telephone. Incomplete grounding may cause electric shock, fires, etc.
- Install residual-current circuit breaker, or electric shock, fires, etc. will occur.
- When contacting electrical components, ensure they are powered off. Contacting the live part may result in the danger of electric shock.
- If there is leakage of the refrigerant gas flow during operation, refrigerant gas is required. If the refrigerant gas contacts any fire, poisonous gases will be produced.

⚠ Attention

- The valve box should be effectively grounded. Electric shocks may occur if the valve box is ungrounded or inappropriately grounded. The wire for earthing shouldn't be connected to the connections on the gas pipe, water pipe, lightning rod or telephone.
- The breaker for electricity leakage should be mounted. If not, accidents such as electric shocks may happen.
- The installed valve box should be checked for electricity leakage by being powered.
- After installation, all cassette concealed valve boxes should be trial-tested. After the proper operation of the machine, other fitments can be made.
- When installing the valve box, please fix the box and connecting pipes in an efficient way to avoid shaking when changing valve box.
- If the ambient humidity bigger than 80%, when the water discharge hole be blocked or the filter becomes dirty, or airflow speed change, there maybe leads to condensing water drop down, and at the same time there maybe some drops of water spit out.
- Keep the valve box, power supply wiring, conductor, etc. at least 1 m away from the TV and radio to avoid image interference and noise. However, sometimes there is still noise when the distance is over 1 m due to the different states of radio waves.
- Try to install valve box where the fluorescent lamp is far away.
- When wireless devices are being installed, the distance that the signal from the controller will reach may be shortened in a room with a fluorescent lamp that is turned on in an electric way (frequency conversion or rapid start).
- Please install the valve box in places where noise will not influence the customers too much (such as washroom, passageway, warehouse, equipment room, etc.). Places with high requirement for quiet are not suggested for installation, such as bedroom, drawing room, meeting room, office, etc.
- When starting up, stop, defrosting, and oil-returning in heating mode, the electronic expansion valve valve will switch and cause noise. This kind of noise is normal for the switching of valve box.

⊘ Prohibitions

- Do not use components other than the fuse of proper capacity, such as metal wire and copper wire, which will cause fires and other faults if used instead of the fuse.
- When doing the cleaning and maintenance, make sure that the operation has been stopped and the manual power switch is in the off position.
- Do not use appliances such as water heater near the valve box. Using appliances producing steam near the valve box may lead to accidents such as water leakage, electric leakage and short circuit when the cooling system is in operation.
- Two-generation valve boxes VP*-*A and VP*-*B can't be mixed used in one system.

Installation instruction

Do not install at such places

1. A place that is filled with mineral oil, a kitchen which has oil and steam everywhere, etc., which may cause degradation, falling off and water leakage of the resinous components.
2. A place with corrosive gases such as sulphurous acid gas, which will lead to the corrosion of the copper tube, welding joint, etc., causing refrigerant leakage.
3. A place where machines give out electromagnetic waves, which will lead to abnormality and improper function of the control system.
4. A place with possible leakage of combustible gases, floating of carbon fiber and combustible dust and use of volatile combustible substances such as diluents, the accumulation of which around the machine set will lead to fires.
5. A place where small animals inhabit, whose contacting the inner electrical components may cause faults, smoking, outbreak of a fire, etc.
6. A coastal place with high salinity and a place with great variation in voltage such as a factory, which may cause faults to vehicles and ships.







Attention item

Install after making sure that the type of the refrigerant used is R410A. If any other type of refrigerant is used, the machine cannot run.



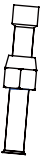





- Before and after the unpacking, if valve box is to be moved, the hoisting handles (totally 4) shall be held firmly. Do not apply force to other parts, especially a refrigerant tube and an electrical cabinet.
- Concerning the installation of the outdoor and indoor units, refer to the installation specification of each unit.



Accessories

Confirm that the accessories below are packed together.

VP4-450B	Auxiliary pipe							
Quantity	4	4	4	4	1	1	1	1
Shape	①-1 Ø6.5  Ø9.52	①-2 Ø9.7  Ø15.88	①-3 Ø12.9  Ø15.88	①-4 Ø19.2  Ø15.88	①-5 Ø9.7  Ø12.7	①-6 Ø16.1  Ø25.4	①-7 Ø19.2  Ø25.4	①-8 Ø16.1  Ø28.58

Installation instruction

VP4-450B	Auxiliary pipe		Wiring harness		Insulation tube			
Quantity	1	1	14	15	1	4	5	1
Shape	①-9 Ø19.2  Ø28.58	①-10 Ø22.4  Ø28.58			 Ø16	 Ø25	 Ø30	 Ø32

VP4-450B	Nut		Specification
Quantity	4	4	1
Shape	 Ø9.52	 Ø15.88	

<Entrustment>

Before the installation is completed, do not abandon the accessories needed in installation.

Combinations

- This series is cooling and heating heat recovery models. Only when the system is equipped with valve box, indoor units under different valve boxes can achieve cooling and heating simultaneously. The modes of the indoors which under the same valve box should be the same. If the indoors connected without valve box, the indoors only can do cooling mode. Do not connect the valve box to the common multi-split system, as the former is dedicated to the cooling & heating multi-split system.
- Concerning the model of the connectible indoor unit, see the sample brochure, etc. for confirmation.
- Concerning the total capacity of the indoor unit connected at the downstream of the valve box (the total selected capacity of the models), select in Table 1 according to the quantity (refer to Table 2 for the selected capacity of the model of each indoor unit)

Table1: Total capacity of indoor unit:

Valve Box	Total of four branches		Per branch	
	Total capacity of indoor unit (kW)	Quantity of indoor unit	Total capacity of indoor unit (kW)	Quantity of indoor unit
VP4-450B	less than 45	less than 20	less than 11.2	less than 5

Table 2: Capacity measure and selected capacity of the model of indoor unit

Capacity measure	072	092	122	162	182	242	282	302	382
selected capacity (KW)	2.2	2.8	3.6	4.5	5.6	7.0	8.0	9.0	11.2

Do not connect the fresh air unit to this system.

Installation instruction

Inspection item

Pay much attention to the following during installation. Check them again after completion.

(1) Inspection items after installation

Inspection item	Defect	Inspection column
If the installation of valve box is secure ?	Falling off, vibration and noise	
If gas leakage inspection is completed ?	No heating/cooling	
If complete insulation is achieved (refrigerant piping and tubing connections) ?	Water leakage	
If the voltage of the power supply is consistent with that on the nameplate ?	Out of service, burnt	
If there is improper wiring or piping ?	Out of service, burnt	
If there is construction without grounding ?	Danger in electric leakage	
If the thickness of the wire is as specified ?	Out of service, burnt	

(2) Inspection upon delivery

Inspection item	Inspection column
If the electric box cover is installed	
If the installation specification is transferred to the customer	

Installation procedure

1. Pre-installation

The installation location selected shall meet the following conditions and be approved by users.

- The strength shall be sufficient to withstand the weight of the valve box
- There is no significant tilt on the plane.
- Ensure that there is enough space for installation and maintenance.as show in Fig.1
- There is space for inspection on the side and top of the electric box
- The length of piping between the indoor and outdoor units shall be within the permissible range (referring to the specification attached to the outdoor unit).
- Please install the valve box in places where noise will not influence the customers too much (such as washroom, passageway, warehouse, equipment room, etc.). Places with high requirement for quiet are not suggested for installation, such as bedroom, drawing room, meeting room, office, etc.

Note:

- the electrical box can be changed as show in 3 valve box installation.
- When starting up, stop, defrosting, and oil-returning in heating mode , the 4-way valve will veer and create noise. This kind of noise is normal for the running of valve box.
- A noise may be emitted by the valve box as aresult of control during operation or stopping of an indoor unit. If it is installed in the ceiling where it is exposed, take adequate precautions with the installation location.

<Notice item>

- Inspect whether the installation location can sufficiently withstand the weight of valve box and set the hoisting bolts by reinforcing the beam if necessary. Use hoisting bolts in installation (referring to 2 for the preparation before installation).
- Install the power wiring and power line of the valve box at more than 1 m away from TV and radio to prevent the image clutter and noise. But, there may be noise even if it is more than 1m according to the different waves.

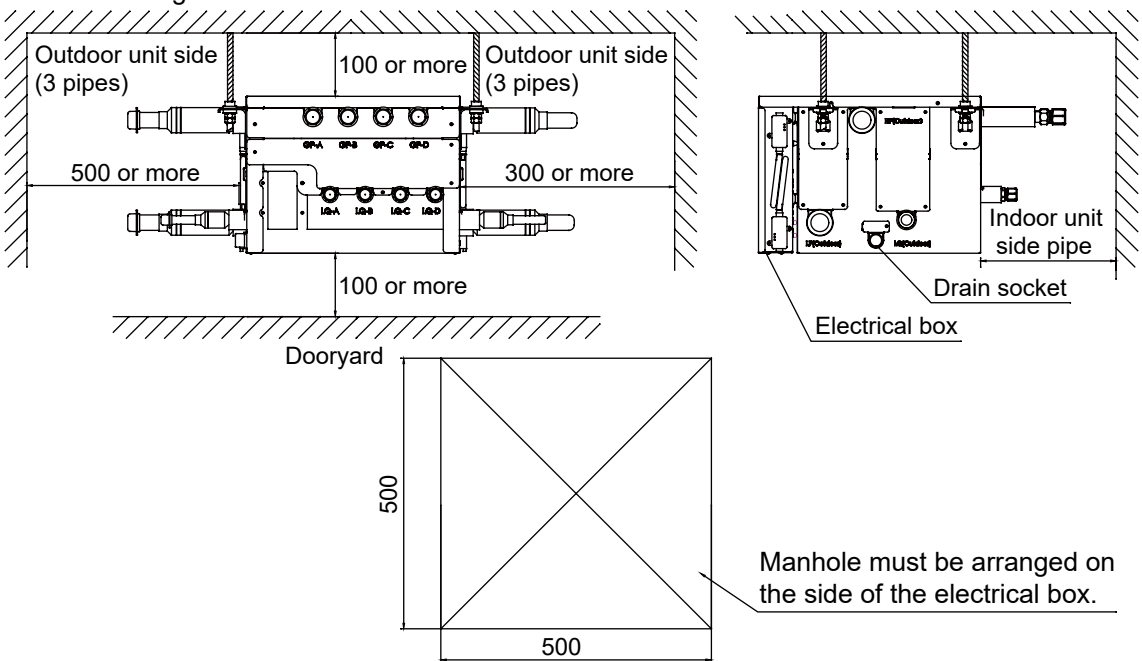

Fig.1

Installation procedure

2. Preparation before installation

(1) Valve box dimension (mm)

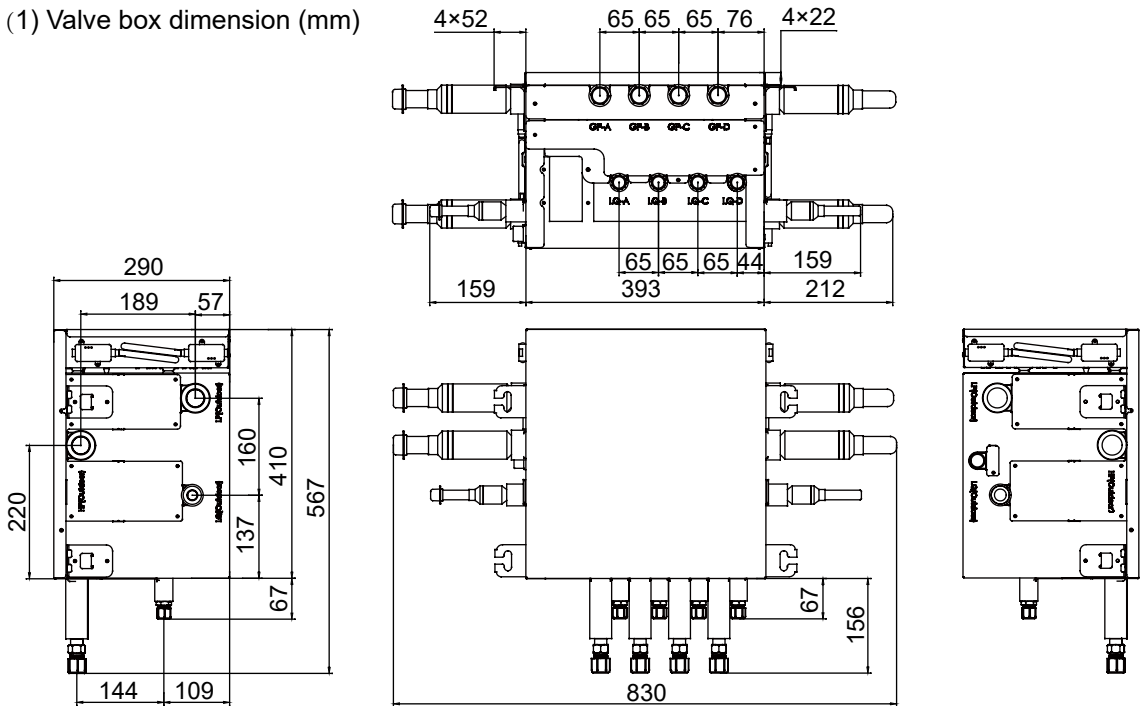

Fig.2

See the Fig.4 to install the lifting bolts and hoisting tools.

- Use the lifting bolts with the size of M8~M10
- Press insert for new settings. Press hole in anchor if set. Ensure that it can sufficiently withstand the weight of the valve box before installation.

(2) Lifting dimension of valve box

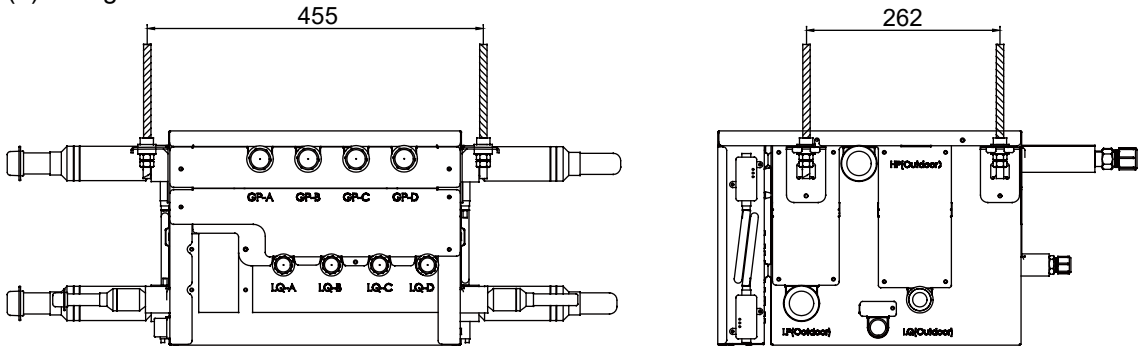

Fig.3 Pitch of lifting bolts

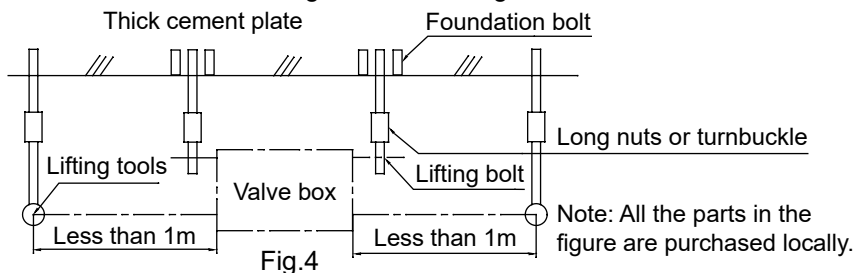

Fig.4

Installation procedure

3. Installation of valve box

Use parts and components specified for installing the installation components.

Install the lifting tools on the lifting bolts according to the instruction of the Fig.5

Be sure to follow the stipulations on products locally purchased to use nuts (M8 or M10 of 3 pieces for 4 positions) and gaskets (M8 with the outer diameter of 24~28 mm and M10 with that of 30~34 mm of 2 pieces for 4 positions) on the upper and lower sides of the lifting tools.

<Note>

Be sure that the product must be installed with the top surface (the oblique surface in the Fig.5) upward, or it will not work well and increase the working noise.

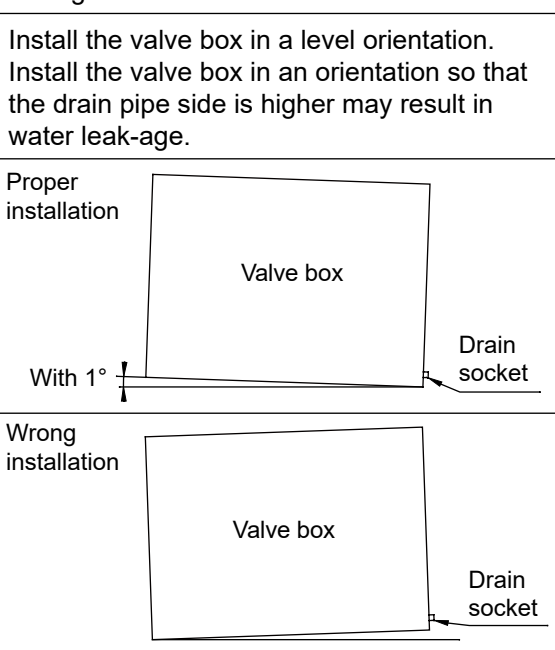
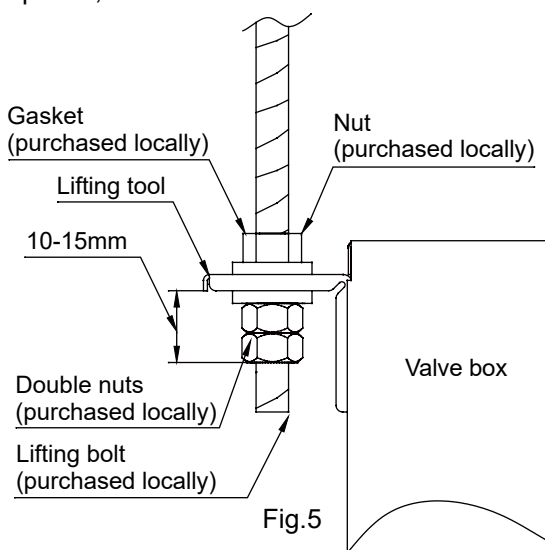

4. Refrigerant pipe Installation

- Pipes between the outdoor unit and valve box, selection of refrigerant branching suite, and the Pipe between refrigerant branching suites and the indoor units, please refer to the installation instructions or equipment design data attached to the outdoor unit.
- Before Installation, make sure the type of the refrigerant to be used is R410A. (If a refrigerant other than this type is used, It cannot run properly)
- Please provide thermal insulation at the high-pressure gas pipe, suction gas pipe, liquid pipe and oil equalizing pipe (pipes for outdoor units in case of multi-split system) and the connections between these pipes. In the absence of thermal insulation, liquid leakage and scalding may happen. Particularly when the high-pressure gas pipe delivers indrawn air under full-refrigeration condition, it needs the same thermal insulation as does the suction gas pipe. Besides, high-pressure gas pipe and suction gas pipe are to deliver high-pressure gas, thus please provide thermal insulation material that can sustain temperature over 120 °C.
- Enhance the thermal insulation material based on the installation environment. The indicators are shown below.
For RH75%–80% at 30°C: over 15 mm thick.
For over 80% at 30°C: over 20 mm thick.
If not reinforced, the thermal insulation material surface is prone to condensation. Please refer to the equipment design data for further details.

Installation procedure

The high-pressure gas pipe, suction gas pipe, liquid pipe must be provided with reliable thermal insulation. In the absence of thermal insulation, liquid leakage may happen.

The outdoor unit is already filled with refrigerant.

To connect the pipes to valve box or remove them from valve box, do use both spanner and torque wrench, as shown in the Fig.6.

Apply refrigerant oil to inside and outside of the flare. Screw it for 3 to 4 rounds with hands and then tighten it.

Determine the tightening torque. (Excessive tightening may damage the nuts and hence cause leakage)

Check the connecting pipes for gas leakage and then fix the thermal insulation, as shown in the in the Fig.7.

Only use sealing gasket to wrap the part jointing between the gas pipe and thermal insulation.

For pipe cutter and flare tool, please use R410A special tools.

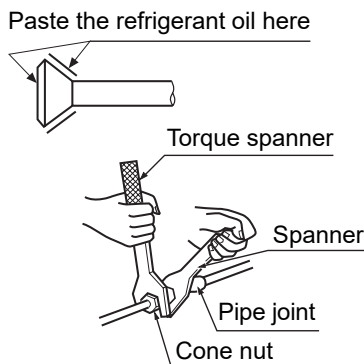

Fig.6

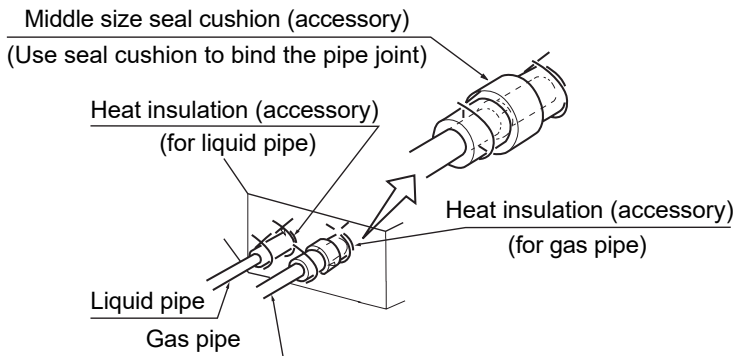

Fig.7

<Notes>

- Please do not let any type of gas other than the specified refrigerant go into the refrigeration system;
- In case of refrigerant leakage during operation, please replace the gas. (Fill the refrigerant at the outdoor unit)

Select piping material

- Make sure both the internal surface and external surface of the pipes are intact and are free from harmful contaminants such as sulphur, oxide, foreign matter, cutting powder, grease and water.
- Please use the following materials for refrigerant pipe.

Pipe material		Phosphorized copper seamless pipe for air conditioner (TP2)
Model		VP4-450B
Function	High pressure gas pipe	Ø28.58
	Suction gas pipe	Ø28.58
	Liquid pipe (outdoor side)	Ø15.88
	Gas pipe (indoor side)	Ø15.88
	Liquid pipe (indoor side)	Ø9.52

Installation procedure

Wall thickness and size: select proper sizes according to **Selection of piping dimensions**

- For the permissible maximum length, permissible elevation difference and permissible length after branching, please refer to the installation instructions or technical data attached to the outdoor unit.
- The branching pipe for the pipe must have refrigerant branching suite. For selection of refrigerant branching suite, please refer to the installation instructions or technical data attached to the outdoor unit.

Piping maintenance

During installation, provide maintenance as specified in the table in order to prevent water, foreign matter and dust from entering the pipes.

Location	Work period	Maintenance method
Outdoors	More than 1 month	Screw
	Less than 1 month	Screw or strap
Indoors	—	

Note

Particularly when a pipe is to penetrate through a wall or extend to outdoors, make sure foreign matter and dust etc cannot enter the pipe.

Attention item for piping connection

- To connect a pipe to or remove it from the valve box, do use pliers for screws and torque spanner;
- When installing the valve box, please fix the box and connecting pipes in an efficient way to avoid shaking when changing valve box.
- For the sizes of the flares, please refer to <Table-1>.

<Note>

- For connection at a flare, apply ester or ether oil to the flare (both inner surface and outer surface). Apply such oil for 3 to 4 times and insert the screw in the first use
- The tightening torque for the flare is given in <Table-1>.

If no torque wrench is available, act as the follows.

- ① Use a spanner to tighten the nut of the flare to a position where the tightening torque sharply increases.
- ② The tightening angle for the position where the tightening torque sharply increases <Table -2>.
- ③ After the work, make sure there is no air leakage.

<Table-1>

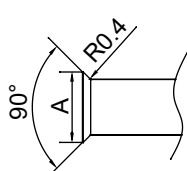
Tube size	Tightening torque (N.m)	Machined flare size A (mm)	Flare shape
Ø6.35	14.2~17.2	8.7~9.1	
Ø9.52	32.7~39.9	12.8~13.2	
Ø12.7	49.5~60.3	16.2~16.6	
Ø15.88	61.8~75.4	19.3~19.7	
Ø19.05	97.2~118.8	23.7—23.9	
Ø22.22	117.2~138.8	28.2-28.5	

Installation procedure

<Table-2>

Pipe size	Tightening angle	Recommended tool length (mm)
Ø6.35	60°~90°	150
Ø9.52	60°~90°	200
Ø12.7	30°~60°	250
Ø15.88	30°~60°	300
Ø19.05	20°~35°	450
Ø22.22	15°~30°	600

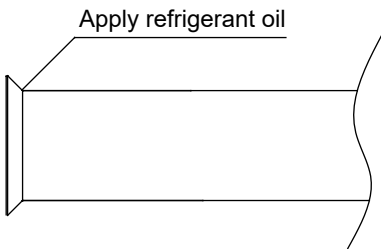

Fig.8

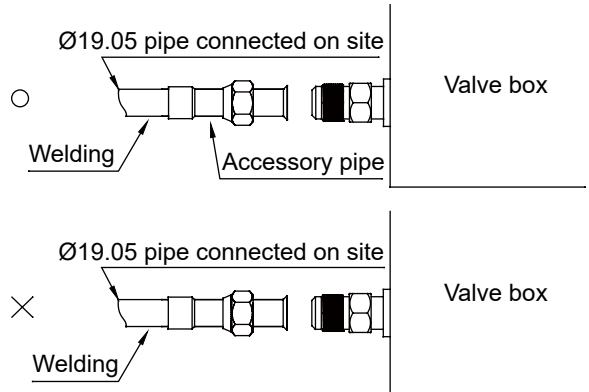

Fig.9

<Note>

- Excessive tightening will result in cracking at the flare and refrigerant leakage.
- To weld the refrigerant pipe, please make nitrogen replacement (*1), or send nitrogen (*2) into the refrigerant pipe while welding the pipe (refer to Fig.10). Finally use the flare or flange to connect the indoor unit and valve box.

(*1) Nitrogen replacement method is provided in the multi-split system work manual.

(*2) If nitrogen flowing and welding proceed simultaneously, do use pressure reducing valve. Approximately 0.02 MPa (0.2 Kg/cm with a slight feeling of breeze) pressure is quite proper.

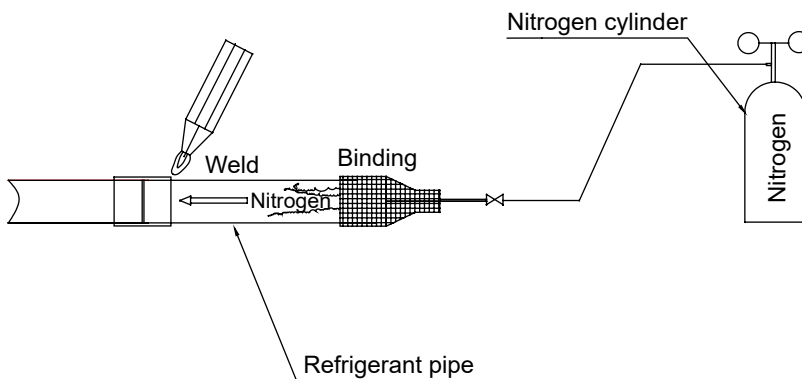

Fig.10

<Note>

- For pipe welding, do not use antioxidant, for its residue may cause tube blocking and component fault.
- For pipe welding, do not use flux. If the flux is chlorine product, it will corrode the tube; if it contains fluorine, it will even cause detrimental effects to the refrigerant system, such as refrigerant oil deterioration. Please do not use phosphor copper for welding material (BCup-2).

Installation procedure

Selection of piping dimensions

Select refrigerant branching dimensions between outdoor units and valve box, between valve box and indoor units according to the following connection examples 1 and 2 and Tables 1-3.

Connection example 1: Connect an indoor unit to the downstream of the valve box

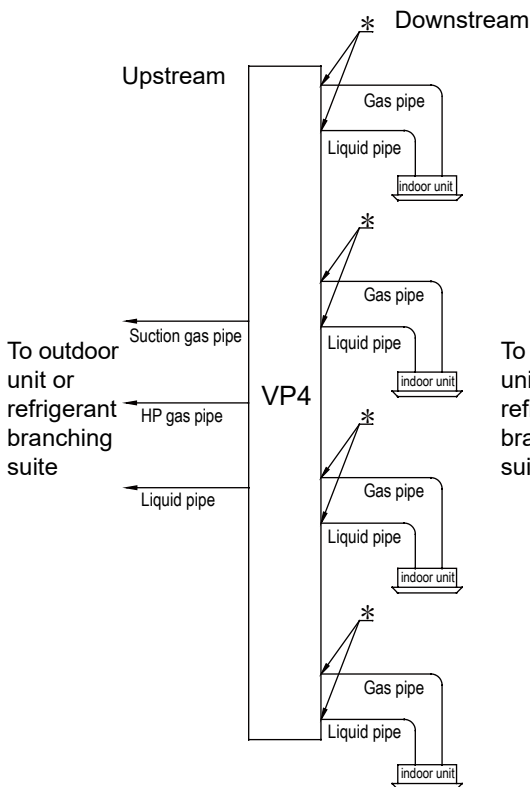

Connection example 2: with branching in the downstream of the valve box

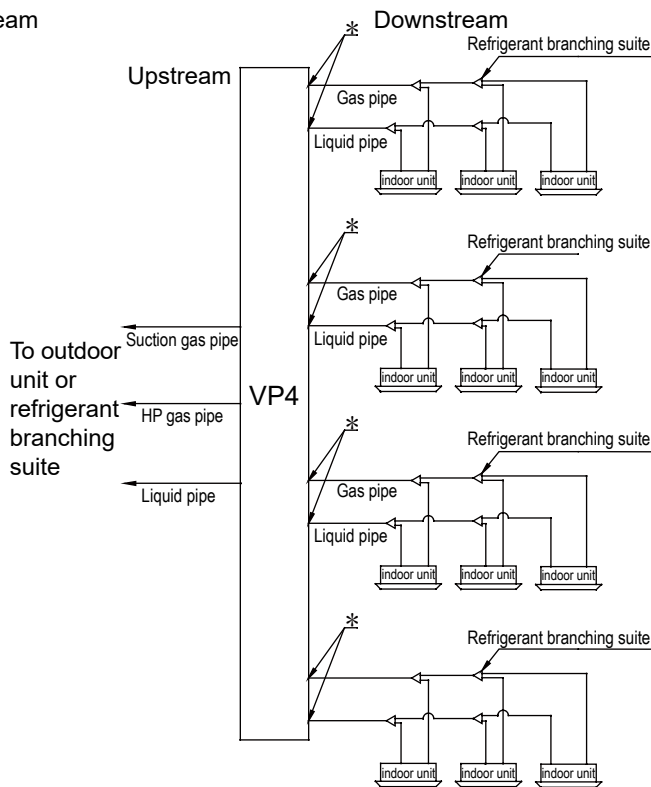

(*) For dimensions of the pipes to the downstream of the valve box, see the table 3. Use the attached pipes for connection in the way shown in **Pipe connection** according to the pipes dimensions and diameters for indoor unit connection selected in Table 2.

<Table 1> Total capacity and pipe dimensions (mm) of the indoor units

Total capacity of the indoor units Q (kW)	Pipe dimensions (OD × minimum wall thickness)		
	Upstream		
	Suction gas pipe	High pressure gas pipe	Liquid pipe
Q < 16.8	Ø15.88 × 1.0	Ø15.88 × 1.0	Ø9.52 × 0.8
16.8 ≤ Q < 22.4	Ø19.05 × 1.0	Ø15.88 × 1.0	Ø9.52 × 0.8
22.4 ≤ Q < 33	Ø22.22 × 1.0	Ø19.05 × 1.0	Ø9.52 × 0.8
33 ≤ Q < 45	Ø28.58 × 1.2	Ø25.4 × 1.2	Ø12.7 × 1.0

Installation procedure

<Table 2> Dimensions (mm) of connection tube of the indoor units

Indoor (×100W)	Gas pipe (mm)	Liquid pipe (mm)
22~28	Ø9.52×0.8	Ø6.35×0.8
36~56	Ø12.7×0.8	Ø6.35×0.8
71~112	Ø15.88×1.0	Ø9.52×0.8

Note:

High wall 0.8/1HP gas pipe: Ø12.7

High wall 2HP gas pipe/liquid pipe: Ø15.88/Ø9.52

<Table 3> Dimensions (mm) of connection pipe of the valve box

Type of valve box for switch between cooling and heating	Pipe dimensions (OD × minimum wall thickness)				
	High pressure gas pipe	Suction gas pipe	Liquid pipe at the outdoor unit side	Gas pipe of the indoor unit	Liquid pipe at the indoor unit side
VP4-450B	Ø28.58×1.2	Ø28.58×1.2	Ø15.88×1.0	Ø15.88×1.0	Ø9.52×0.8

Pipe connection

(*1) Refer to the field pipe

(*2) Please use the flare nut installed on the product body again.

Note:

During installation, please confirm the HP gas pipe and Suction gas pipe between outdoor and valve box (such as by sending nitrogen into the HP gas pipe and Suction gas pipe), then connect Suction gas pipe to the Suction gas pipe of valve box, HP gas pipe to the HP gas pipe of valve box.

(Note):

When a 072, 092, 22 or 28 indoor unit is connected in the downstream, please use the auxiliary pipe ①-1,2 for connection according to Fig.11.

When a 122, 162, 182, 36, 45 or 56 indoor unit is connected in the downstream, please use the auxiliary pipe ①-1,3 for connection according to Fig.11.

When a High wall 0.8/1HP indoor unit is connected in the downstream, please use the auxiliary pipe ①-1,3 for connection according to Fig.11.

When an High wall 2HP indoor unit is connected in the downstream, do not use the auxiliary pipe.

Installation procedure

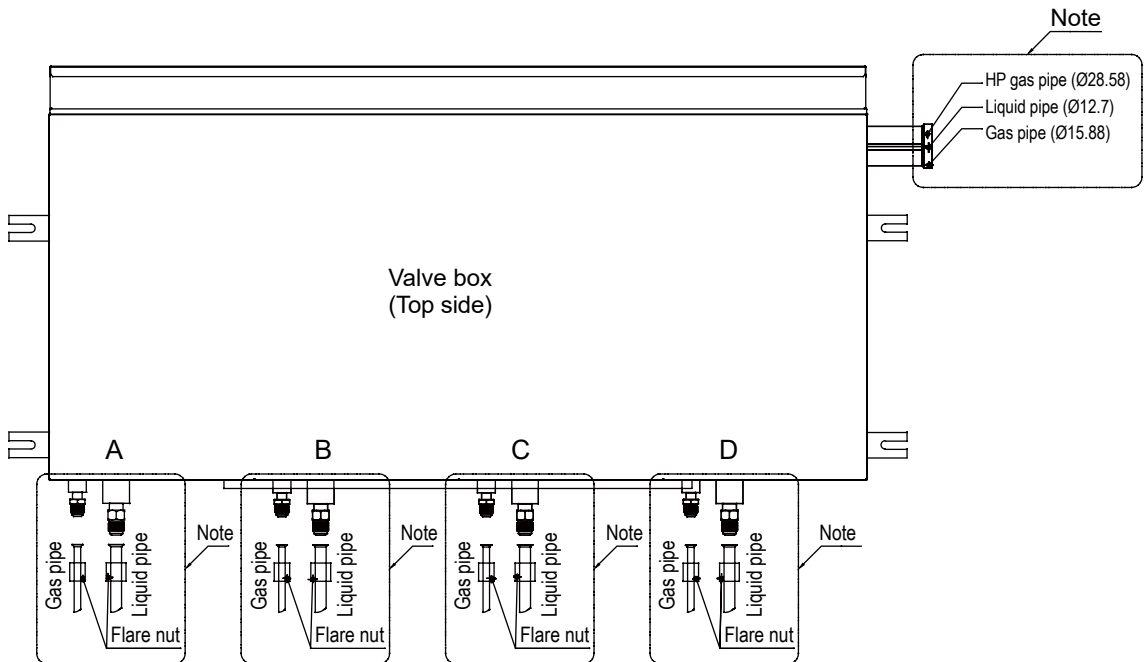

Fig.11

Installation procedure

Pipe insulation

Please use the auxiliary insulation cylinder and anchor for insulation works according to Fig.12 after the gas leakage test.

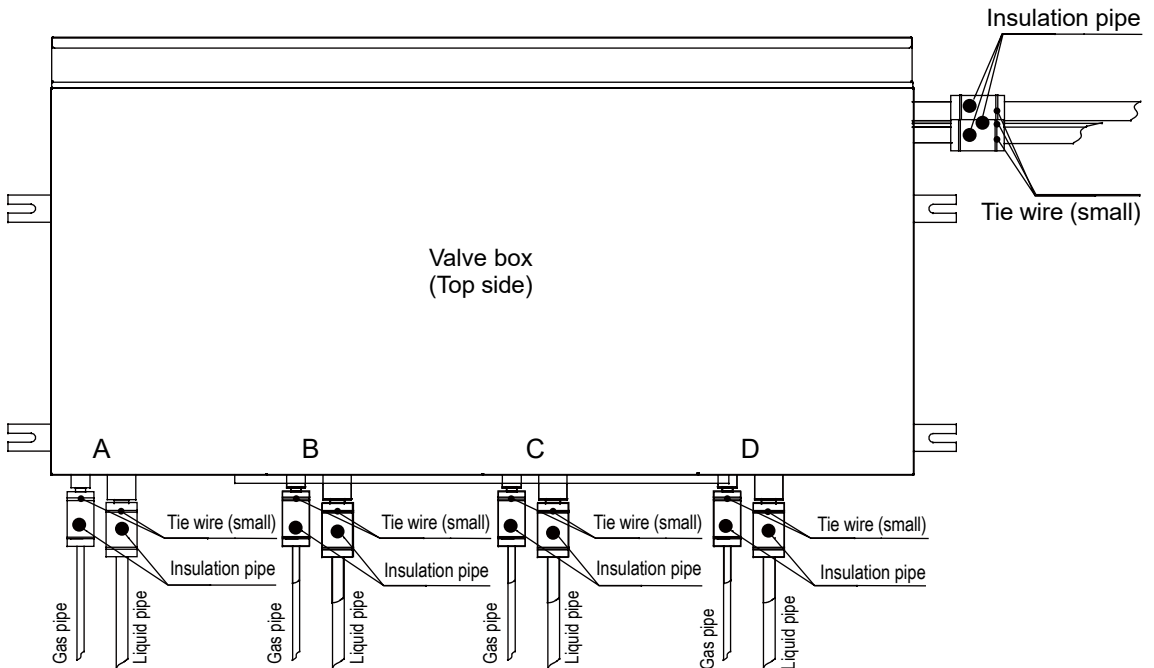

Fig.12

Note 1:

For suction gas pipes, high pressure gas pipe and liquid pipes, gas pipe, flare connections shall be wrapped with insulation materials (purchased locally) when their auxiliary insulation cylinders have been installed.

For installation of insulation materials for the flare nut connections, it shall be cautioned that:

- (1) Please connect it tightly so as to ensure no gas leakage at both ends.
- (2) The retaining clamp shall not be over tight so as to ensure the thickness of the insulation materials.
- (3) Joints of insulation materials (purchased locally) for the upper flare nut connections shall be wrapped upwards.
- (4) Ensure that joints of the insulation materials are installed upwards. (See Fig.13.)

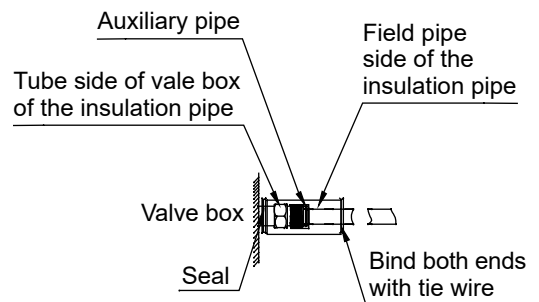

Fig.13

Electrical wiring

⚠ Warning

- Electrical construction should be made with specific mains circuit by the qualified personnel according to the installation instruction. Electric shock and fire may be caused if the capacity of power supply is not sufficient.
- During arranging the wiring layout, specified cables should be used as the mains line, which accords with the local regulations on wiring. Connecting and fastening should be performed reliably to avoid the external force of cables from transmitting to the terminals. Improper connection or fastness may lead to burning or fire accidents.
- There must be the ground connection according to the criterion. Unreliable grounding may cause electrical shocks. Do not connect the grounding line to the gas pipe, water pipe, lightning rod and telephone line.

⚠ Attention

- Only copper wire can be used. Breaker for electric leakage should be provided, or electric shock may occur.
- The wiring of the mains line is of Y type. The power plug L should be connected to the live wire and plug N connected to null wire while ⊕ should be connected to the ground wire. For the type with auxiliary electrically heating function, the live wire and the null wire should not be misconnected, or the surface of electrical heating body will be electrified. If the power line is damaged, replace it by the professional personnel of the manufacturer or service center.
- The power line of valve boxes should be arranged according to the installation instruction of valve boxes.
- The electrical wiring should be out of contact with the high-temperature sections of tubing as to avoid melting the insulating layer of cables, which may cause accidents.
- After connected to the terminal tier, the tubing should be curved into be a U-type elbow and fastened with the pressing clip.
- Controller wiring and refrigerant tubing can be arranged and fixed together.
- The machine can't be powered on before electrical operation. Maintenance should be done while the power is shut down.
- Seal the thread hole with heat insulating materials to avoid condensation.
- Signal line and power line are separately independent, which can't share one line. [Note: the power line, signal line are provided by users. Parameters for power lines are shown as below: $3 \times (1.0-1.5) \text{ mm}^2$; parameters for signal line: $2 \times (0.75-1.25) \text{ mm}^2$ (shielded line)]
- Valve boxes and outdoor units should be connected to the power source separately. All valve boxes must share one single electrical source, but its capacity and specifications should be calculated. Indoor & outdoor units should be equipped with the power leakage breaker and the overflow breaker.
- Valve box can be installed in multiple, named as unit A, unit B.... Pay attention to the marks on the terminal block when connecting the outdoor unit with the indoor unit. Refer to wiring example as described in 5-2 while ensuring correct connection. In addition, the operation will be abnormal when the wiring and the tubing between indoor and outdoor machine sets are installed in different refrigerant systems.
- Energization is not to be done before it's confirmed that the valve box have completely installed and that the outdoor and indoor installation is completed.

Electrical wiring

The wiring for the power line and signal line of valve box

The wiring for the power line of valve box, the wiring for the signal line between valve boxes and outdoor units as well as the wiring between valve boxes.

Total Current of valve boxes (A)	Items	Cross Section (mm ²)	Rated Current of Overflow Breaker (A)	Rated Current of Power Leakage Breaker (A) Leaking Current (mA) Operating Period (S)	Cross Sectional Area of Signal Line	
					Outdoor-valve box (mm ²)	Valve box-valve box (mm ²)
<15		2.5	15	15A, 30mA, 0.1S or below	2cores ×0.75-2.0 mm ² shielded line	

- Power cable and communication wire must be fixed firmly.
- Each valve box must be earthed well.
- When power cable exceeds the range, thicken it appropriately.
- Shielded layer of communication wires must be connected together and be earthed at single point.
- Communication wire total length cannot exceed 1000m.

Graphical representation for wiring

Connect the communication terminal block P and Q of the main unit of the outdoor units with the communication terminal block P and Q of the first valve box (VP 1).

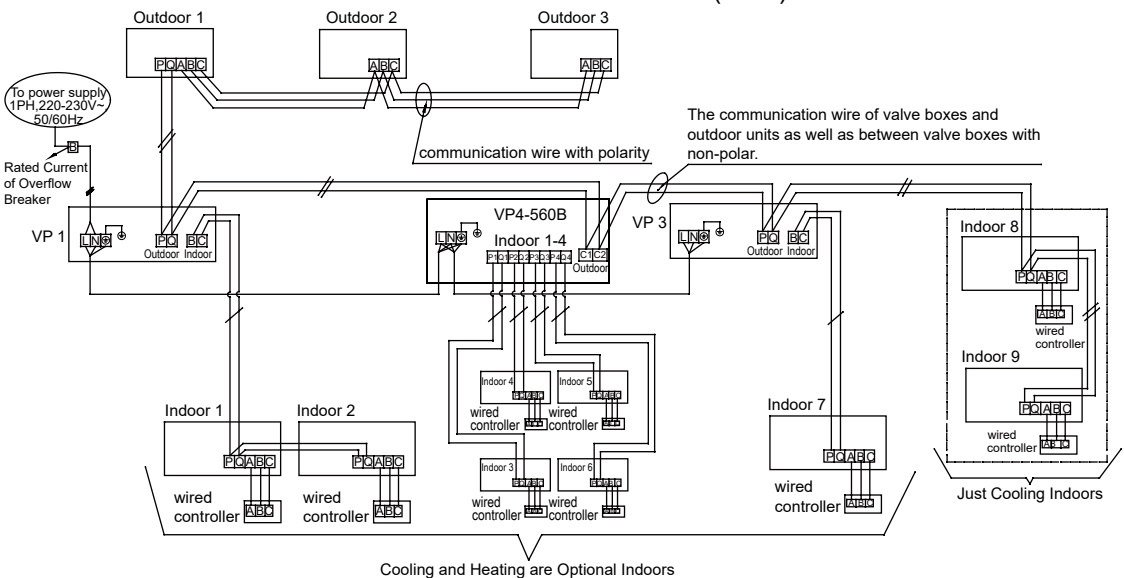

Notes:

- (1) The above wiring example is only for reference. The number of valve boxes and indoor units shall be subject to the field installation.
- (2) Communication line from cooling-only indoor unit may be connected to the communication terminal block P and Q (outdoor) of the valve box.

Electrical wiring

- (3) Two-core nonpolar communication line with shield shall be adopted for communication lines between the valve box and the indoor/outdoor unit. Three-core polar communication line with distinguished polarities and shield shall be adopted for the wire controller connected to the indoor unit.
- (4) All valve boxes within one system may share one overcurrent breaker for power supply. But it's necessary to compute total current capacity specification.
- (5) For wiring harness connected to the power terminal block, the terminal shall be pressed with a round (refer to the following figure).

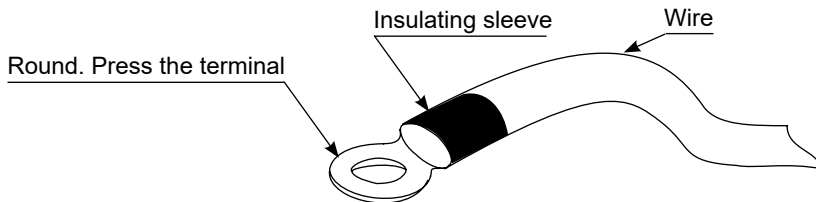

- 1) The power terminal block shall not be crimped with 2 wires of different diameters. Otherwise, poor crimp connection and looseness may lead to abnormal heating or sparking of the line.
- 2) Refer to the following figure for crimping wires with the same diameter.

Connect wires with the same diameter on both sides

It's forbidden to connect two wires on one side

Wires with different diameters are not allowed

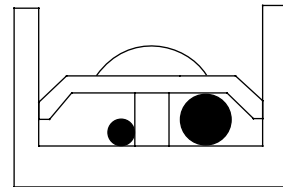
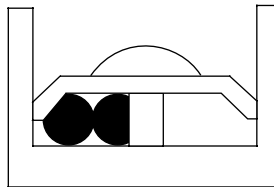
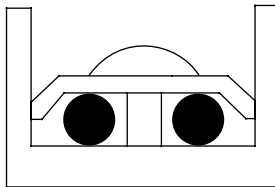

- (6) Tighten terminal screws with proper screw driver. Screw driver of small dimension will damage the screw head and fail to tighten properly.
- (7) If terminal screws are tightened excessively, they may be damaged. Refer to the following table for tightening torques of terminal screws:

Dimension of terminal screw	Tightening torque (N.m)
M3.5 (terminal block for communication line)	0.80~0.96
M4 (terminal block for power line)	1.18~1.44
M4 (terminal block for ground wire)	1.52~1.86

- (8) Power line is forbidden to the communication terminal block because it will damage the circuit control board.
- (9) Wiring of communication lines shall be within the following scope. Exceeding the limit will possibly lead to abnormal communication.
 - 1) The maximum wiring length between the outdoor machine and the valve cage, the valve cage and the indoor machine, and between valve cages is 1000 m at most. The total wiring length is 2000m at most. The maximum branch number is 16.
 - 2) The maximum wiring length between the valve cage and the wire controller for switching working modes is 500 m at most.

Electrical wiring

Wiring connection

Refer to the following figure – Diagram of electrical wiring of a valve box – for wiring connection of valve box.

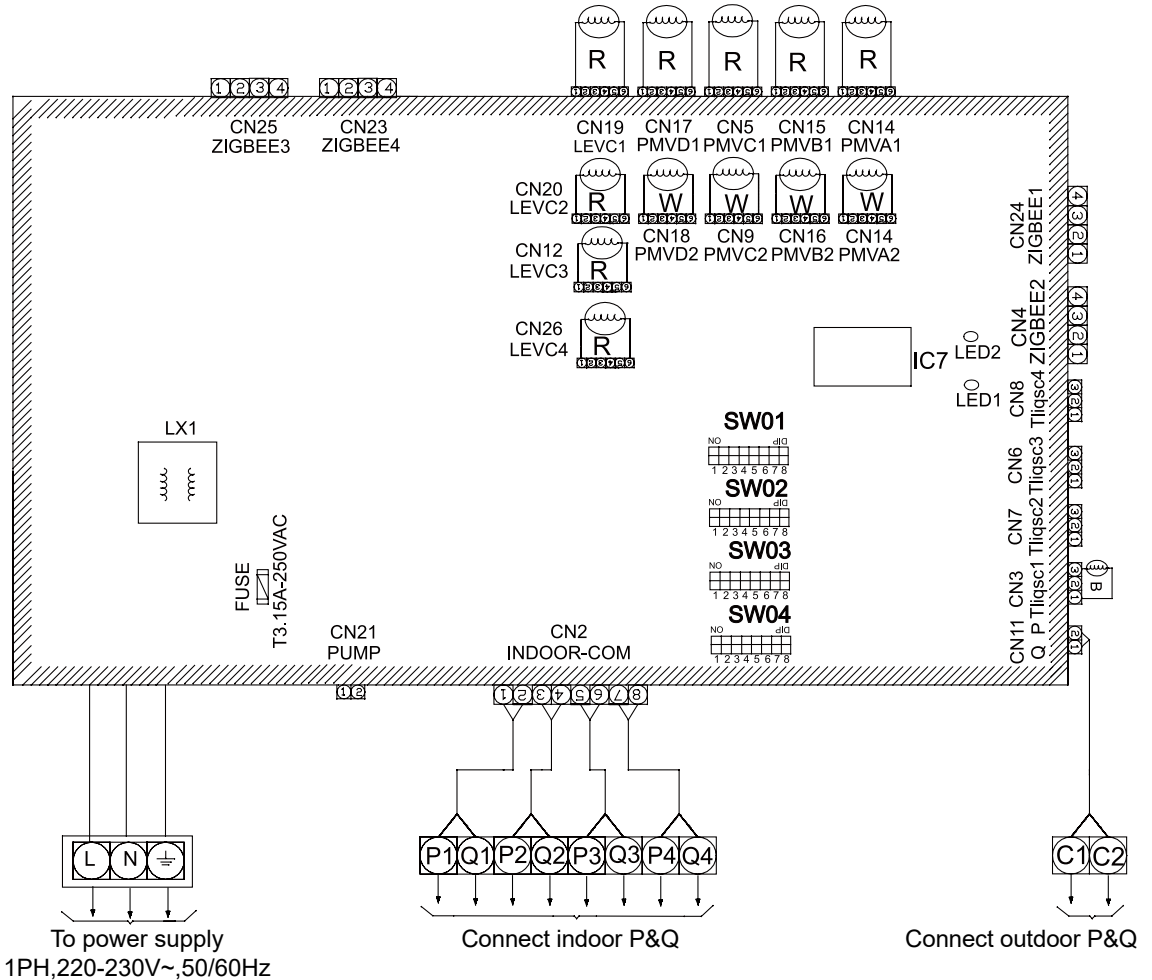

Notice:

The colours use these letters for short
W:White B:Black R:Red Y:Yellow BL:Blue

Electrical wiring

(1) Connection communication line

Remove the cover of the electrical cabinet of the valve cage. Introduce communication lines for outdoor and indoor units to the through holes at the lower right of the electrical cabinet and crimp them on the communication terminal block respectively. Then fix the lead wires with crimping pliers to prevent the communication line from falling off under the effect of external force.

(2) Connection of power line and ground wire

Remove the cover of the electrical cabinet of the valve box. Introduce power lines to the through holes at the lower left of the electrical cabinet and crimp them on the communication terminal block. Then fix the power lines with crimping pliers to prevent them from falling off under the effect of external force.

- 1) Don't route communication lines and power lines together. Otherwise, it may cause malfunction or fault due to electrical disturbance.
- 2) Make sure that ground wires are properly crimped. Otherwise, grounding may be ineffective.

Initial setting

Operate according to the following setting as necessary after refrigerant piping construction and electrical wiring construction are finished.

Code setting for the postal address of the valve box:

SW03 is used for valve box address setting, 1 is ON, 0 is OFF.

SW03_1	Manner of set address	0						Set the address with automatism (default)
		1						Set the address with dip switch
SW03_2	Pre-set	0						Pre-set (default)
		1						Pre-set
SW03_3 ~ SW03_8	Set the communication address with dip switch	[3]	[4]	[5]	[6]	[7]	[8]	Communication address
		0	0	0	0	0	0	0# (default)
		0	0	0	0	0	1	1#
		0	0	0	0	1	0	2#
		0	0	0	0	1	1	3#
		0	0	0	1	0	0	4#
		0	0	0	1	0	1	5#
		0	0	0	1	1	0	6#
		0	0	0	1	1	1	7#
		0	0	1	0	0	0	8#
		0	0	1	0	0	1	9#
		0	0	1	0	1	0	10#
		0	0	1	0	1	1	11#
		0	0	1	1	0	0	12#
		0	0	1	1	0	1	13#
		0	0	1	1	1	0	14#
		0	0	1	1	1	1	15#
		0	1	0	0	0	0	16#
		0	1	0	0	0	1	17#
		0	1	0	0	1	0	18#
		0	1	0	0	1	1	19#
		0	1	0	1	0	0	20#
		0	1	0	1	0	1	21#
		0	1	0	1	1	0	22#
		0	1	0	1	1	1	23#
		0	1	1	0	0	0	24#
		0	1	1	0	0	1	25#
		0	1	1	0	1	0	26#
		0	1	1	0	1	1	27#
		0	1	1	1	0	0	28#
		0	1	1	1	0	1	29#
		0	1	1	1	1	0	30#
		0	1	1	1	1	1	31#
		1	0	0	0	0	0	32#
		1	0	0	0	0	1	33#
1	0	0	0	1	0	34#		
1	0	0	0	1	1	35#		

Initial setting

		[3]	[4]	[5]	[6]	[7]	[8]	Communication address
		SW03_3 ~ SW03_8	Set the communication address with dip switch	1	0	0	1	0
		1	0	0	1	0	1	37#
		1	0	0	1	1	0	38#
		1	0	0	1	1	1	39#
		1	0	1	0	0	0	40#
		1	0	1	0	0	1	41#
		1	0	1	0	1	0	42#
		1	0	1	0	1	1	43#
		1	0	1	1	0	0	44#
		1	0	1	1	0	1	45#
		1	0	1	1	1	0	46#
		1	0	1	1	1	1	47#
		1	1	0	0	0	0	48#
		1	1	0	0	0	1	49#
		1	1	0	0	1	0	50#
		1	1	0	0	1	1	51#
		1	1	0	1	0	0	52#
		1	1	0	1	0	1	53#
		1	1	0	1	1	0	54#
		1	1	0	1	1	1	55#
		1	1	1	0	0	0	56#
		1	1	1	0	0	1	57#
		1	1	1	0	1	0	58#
		1	1	1	0	1	1	59#
		1	1	1	1	0	0	60#
		1	1	1	1	0	1	61#
		1	1	1	1	1	0	62#
		1	1	1	1	1	1	63#

Notes:

The postal address setting is written in the chip during energization of the valve box

- 1) Make sure that the postal address code is set before the valve box is energized.
- 2) Be sure to close the cover of the electrical cabinet after setting.

Commissioning

1. Confirm that the cover of the electrical cabinet of the valve box is of good sealing.
2. Conduct commissioning in accordance with the installation and use specification attached to the outdoor unit.
At the time of energization, because electronic expansion valve will start initialization (open/close), there may be click lasting for about 20s, which is normal.
3. In case of faulty valve cage, the trouble light LED3 (red) of the computer board of the valve cage will flicker periodically. Find the cause of fault according to the flickering frequency of LED3, as shown in the following table:

Valve box failure code list

Failure code	Failure code definition	Judgment method	Remarks
5	Valve box EEPROM date failure		Un-resumable
6	Communication between valve box and outdoor failure	No communication with the outdoor unit for continuous 120 seconds	Resumable
7	Communication between valve box and indoor failure	When detecting the connected indoor units, the indoor unit quantity is zero.	Resumable
9	Valve box repeated address		Resumable
20	Outdoor corresponding failure		Resumable

